

Magnescape®

Counter Unit

LY72

Read all the instructions in the manual carefully before use and strictly follow them.
Keep the manual for future references.

Instruction Manual (Installation Manual)

[For U.S.A. and Canada]

THIS CLASS A DIGITAL DEVICE COMPLIES WITH PART15 OF THE FCC RULES AND THE CANADIAN ICES-003. OPERATION IS SUBJECT TO THE FOLLOWING TWO CONDITIONS.

- (1) THIS DEVICE MAY NOT CAUSE HARMFUL INTERFERENCE, AND
- (2) THIS DEVICE MUST ACCEPT ANY INTERFERENCE RECEIVED, INCLUDING INTERFERENCE THAT MAY CAUSE UNDERSIGNED OPERATION.

CET APPAREIL NUMÉRIQUE DE LA CLASSE A EST CONFORME À LA NORME NMB-003 DU CANADA.

[For the customers in Australia]

Australian EMC Notice

This product complies with the following Australian EMC standards.

- AS/NZS 4252.1 /94 EMC Generic Immunity Part1
- AS/NZS 2064 /92 Emission Standard for ISM Equipment

Safety Precautions

Magnescale Co., Ltd. products are designed in full consideration of safety. However, improper handling during operation or installation is dangerous and may lead to fire, electric shock or other accidents resulting in serious injury or death. In addition, these actions may also worsen machine performance.

Therefore, be sure to observe the following safety precautions in order to prevent these types of accidents, and to read these "Safety Precautions" before operating, installing, maintaining, inspecting, repairing or otherwise working on this unit.

Warning indication meanings

The following indications are used throughout this manual, and their contents should be understood before reading the text.

Warning

Failure to observe these precautions may lead to fire, electric shock or other accidents resulting in serious injury or death.

Caution

Failure to observe these precautions may lead to electric shock or other accidents resulting in injury or damage to surrounding objects.

Symbols requiring attention



CAUTION



FIRE



ELECTRICAL
SHOCK

Symbols prohibiting actions



DO NOT
DISASSEMBLE

Symbols specifying actions



UNPLUG-
GING

Warning



Do not use with other than the specified power voltage.

Do not use the counter unit with other than the indicated power voltage, and do not connect multiple plugs to a single output.



Do not place a load on the power cord.

Do not damage, modify, excessively bend, pull on, place heavy objects on, or heat the power cord, as this may damage the power cord. Be sure to grip the power plug when unplugging it from the socket.

Be sure to connect the ground.

The power cord includes a safety ground, so be sure to connect this ground. Failure to properly connect the ground may lead to fire or electric shock.

Failure to observe these precautions may result in fire or electric shock.



Do not expose to inflammable gases.

The counter unit does not have an explosion-proof structure. Therefore, do not use the unit in an atmosphere charged with inflammable gases

Failure to observe this precaution may result in fire.



Do not handle the plug with wet hands.

Do not plug in, unplug or otherwise handle the power plug with wet hands.

Failure to observe this precaution may result in electric shock.



Do not disassemble.

Do not open the cover of the counter unit to disassemble or modify the unit.

Failure to observe this precaution may result in burns or injury.

Caution



Do not leave the power plug plugged in when not used.

When the unit will not be used for an extended period of time, be sure to unplug the power plug from the socket for safety.



Do not connect or disconnect the connectors with the power on.

Be sure to turn off the power before connecting or disconnecting power and signal connectors in order to prevent damage or misoperation.

Do not use in moving areas or areas exposed to strong shocks.

The unit does not have an earthquake-proof structure. Therefore, do not use the unit in moving areas or areas exposed to strong shocks.

Do not use the power cords for other products.

Do not use the power cord included in optional AC adaptor package for any other product.

Failure to observe this precaution may result in electric shock.

General precautions

When using Magnescale Co., Ltd. products, observe the following general precautions along with those given specifically in this manual to ensure proper use of the products.

- Before and during operations, be sure to check that our products function properly.
- Provide adequate safety measures to prevent damage in case our products should develop a malfunction.
- Use outside indicated specifications or purposes and modification of our products will void any warranty of the functions and performance as specified for our products.
- When using our products in combination with other equipment, the functions and performance as noted in this manual may not be attained, depending upon the operating environmental conditions. Make a thorough study of the compatibility in advance.

Contents

1. Before Use	1-1
1-1. Item List	1-1
1-2. Features	1-2
1-3. System Configuration	1-3
2. Name and Function of Each Part	2-1
2-1. Front Panel	2-1
2-2. Rear Panel	2-3
3. Installation and Connection	3-1
3-1. Installation	3-1
3-2. Connection	3-2
3-3. RS-232C Input and Output	3-4
4. Settings	4-1
4-1. Enabling Operation (When Using the LY72 for the First Time)	4-1
4-2. Making and Changing Basic Settings	4-3
4-2-1. Axis label	4-5
4-2-2. Master calibration (When the axis label ABC is selected only)	4-5
4-2-3. Input axis	4-6
4-2-4. Destination country	4-6
4-2-5. Measuring unit resolution	4-6
4-3. Advanced Settings	4-7
4-3-1. Display at power ON	4-13
4-3-2. Display resolution and polarity	4-13
4-3-3. Display axis, and display data at power ON (When the axis label ABC is selected only)	4-13
4-3-4. Display data axis (when the axis label XYZ is selected only)	4-14
4-3-5. Scaling	4-14
4-3-6. Linear compensation	4-15
4-3-7. Hold function	4-15
4-3-8. General-purpose input	4-15
4-3-9. General-purpose output	4-18
4-3-10. Key lock	4-19
4-3-11. Current value store	4-20
4-3-12. Flicker control	4-20
4-3-13. Sleep	4-20
4-3-14. Output data mode	4-20
4-3-15. RS-232C data output format (when Computer mode is selected by Output data mode only)	4-20
4-3-16. Output data selection (when axis the label ABC is selected only)	4-21
4-3-17. Timer (when the axis label ABC is selected only)	4-21
4-3-18. Transfer rate	4-21
4-3-19. Parity	4-21
4-3-20. Stop bit	4-21
4-3-21. Data length	4-21
5. Specifications	5-1
6. Dimensions	6-1

7. Alarm Display	7-1
8. Troubleshooting	8-1
9. Supplement.....	9-1
9-1. Setting Flowcharts	9-1
9-1-1. Basic settings	9-1
9-1-2. Advanced settings (When axis label ABC is selected)	9-2
9-1-3. Advanced settings (When axis label XYZ is selected)	9-5
9-2. Key Operations	9-8

1. Before Use

This instruction manual is intended for use outside Japan.

1-1. Item List

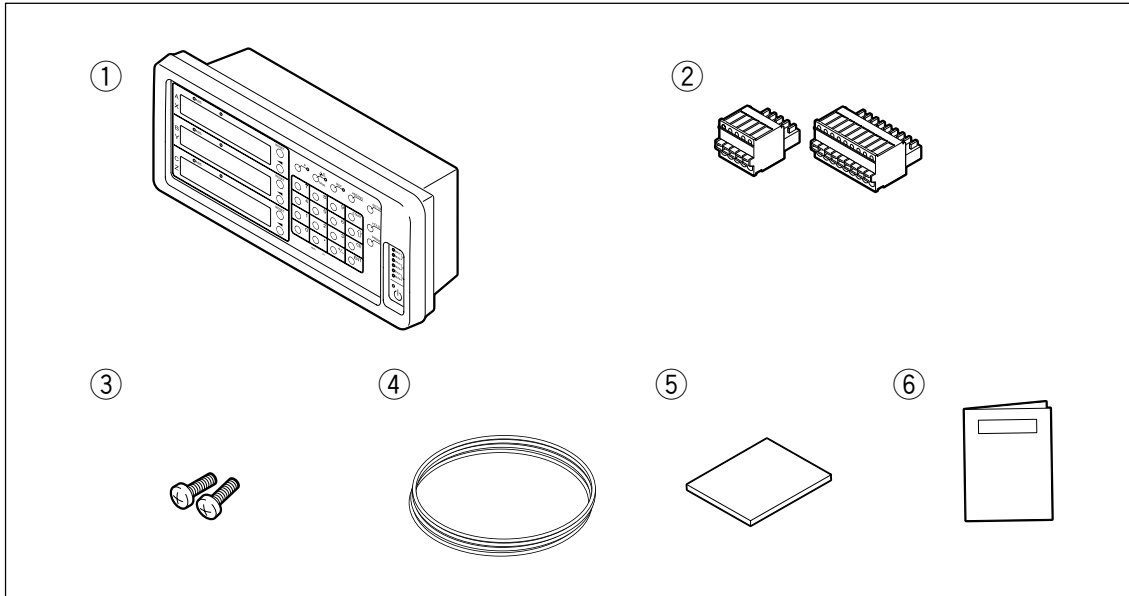

Item	Quantity
① LY72	1
② External I/O terminal block connectors	2
③ Anchor bolts (M4 × 16)	2
④ Ground wire	1
⑤ CD-ROM (Installation Manual, Operating Manual)	1
⑥ Supplement	1

1-2. Features

Peak Hold Function Convenient for Statistical Measurement

It can be set to hold maximum, minimum and peak-to-peak values in counting.

Convenient External Input Functions for Automatic Measurement

In addition to external reset and external preset value call functions, general-purpose inputs are available in the external interface for operations useful for automatic measurement. (The general-purpose inputs can be used as various signal inputs according to the advanced settings.)

RS-232C I/O

The current value, maximum value, minimum value and peak-to-peak value can be extracted by RS-232C communication. In addition, key operations and various other operations can be input as RS-232C commands.

Display Resolution Switching

The display resolution can be selected from the following.

Linear : 0.1 μm to 10 μm

Angles : 1 second to 10 minutes

(Choose the appropriate setting for the connected measuring unit.)

Data Storage

Displayed data and preset data are stored automatically.

Therefore, data can be easily relocated even after the power is turned off or in case of a temporary power failure. (You can select whether to use held values.)

Preset

Each axis can have up to three preset values.

This is useful when setting multiple preset values.

Detecting Reference Point of Measurement Unit

When connected measuring units with build-in reference points, reference points can be detected whenever needed and used as absolute reference points in measurement.

Scaling

The counter can be set to display actual measurement by any multiplier, either scaling-up or scaling-down, within the setting range.

This function is especially helpful in handling contract in materials such as resin and so on when making dies by converting product dimensions to die ones.

Flicker Control

Flicker on the least significant digital caused by connected higher resolution measuring units or vibration from machine tools on which measuring units are installed can be eased by enabling flicker control function.

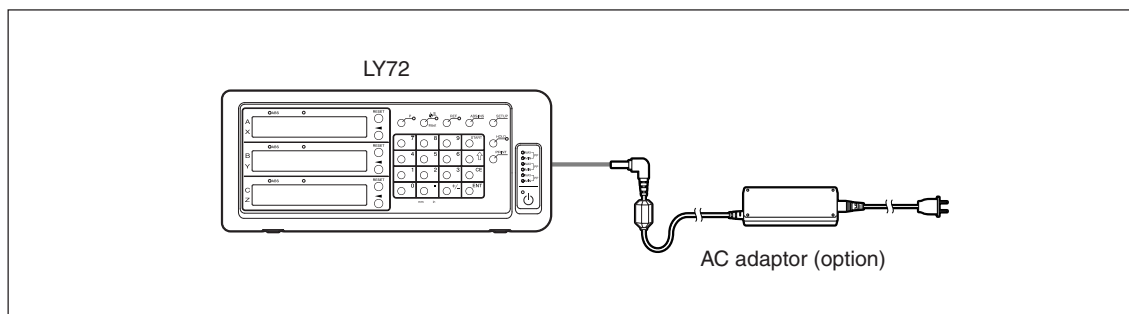

1-3. System Configuration

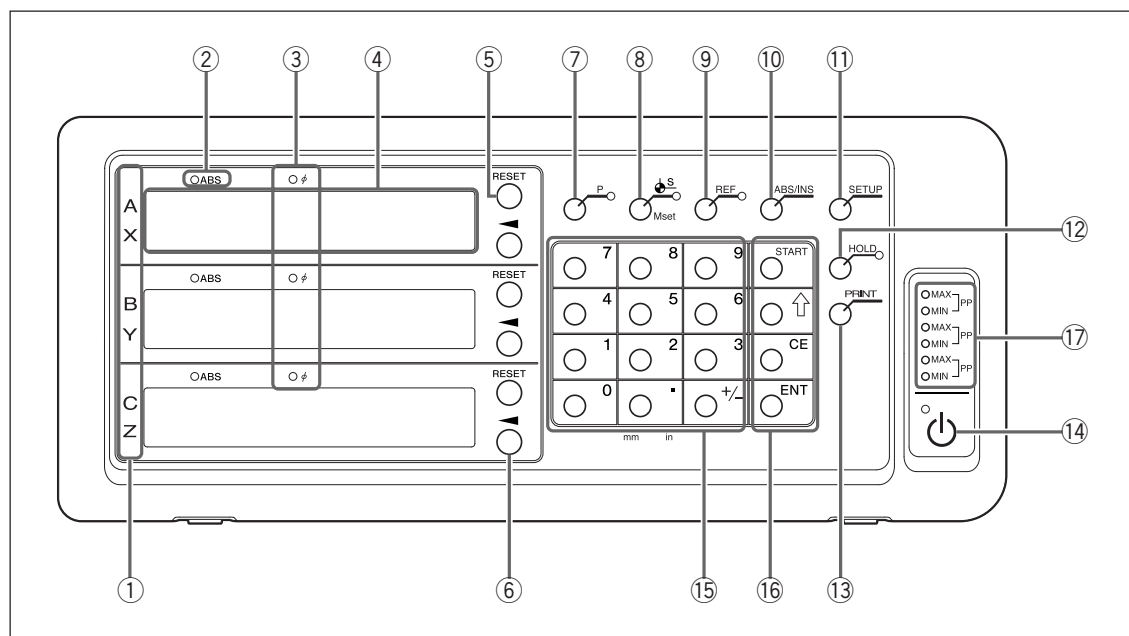

2. Name and Function of Each Part

2-1. Front Panel



No.	Name	Function
①	Axis label	ABC or XYZ can be selected. Flashing : Selected axis
②	ABS lamp	Lights on : When displaying absolute value (ABS) Lights off : When displaying incremental value (INC)
③	φ lamp	Lights on : Diameter display Lights off : Normal display
④	Counter display	ABC / XYZ : Measurement value display (current value, peak value) Shows status with alphabetical letters when making mode settings (See "7. Alarm Display" when an error occurs.)
⑤	RESET key	Resets incremental value to zero Switches to INC mode when pressed during ABS display.
⑥	Axis Select key	Selects an axis for the following operations undertaken thereafter are to the axis
⑦	P key	Used to perform numerical value setting operations (preset) (lamp lights on when selected)
⑧	 S key (Datum Point Value/ Master Calibration Value Setting key)	Used to set the datum point (lamp lights on when selected) Used to set the master calibration value when using the master calibration function
⑨	REF key	Used to detect the measuring unit reference point (lamp lights on when selected) Used to relocate the master calibration value when using the master calibration function
⑩	ABS/INC key	Switches between ABS mode and INC mode
⑪	SETUP key	Used to start to make various settings
⑫	HOLD key	Used when using the hold function (latch/pause) (lamp lights on when hold function is selected)
⑬	PRINT key	Used to output data to a RS-232C device
⑭	 key (Standby key)	Turns power ON and OFF Lamp in upper left : Lights on: Power OFF Flashing : Startup Lights off: Power ON

2. Name and Function of Each Part

⑮	Numeric keys	Performs numerical value input	
⑯	Function keys	Used to perform various operations	
		START key	Used to start recalculation of peak value
		↑ key	Advances to next setting item
		CE key	Cancels numerical value input and various function key operations
	ENT key	Validate settings	
⑰	Peak Value lamps	MAX lights on	: When displaying maximum value
		MIN lights on	: When displaying minimum value
		Both MAX and MIN light on	: When displaying peak-to-peak value

2-2. Rear Panel

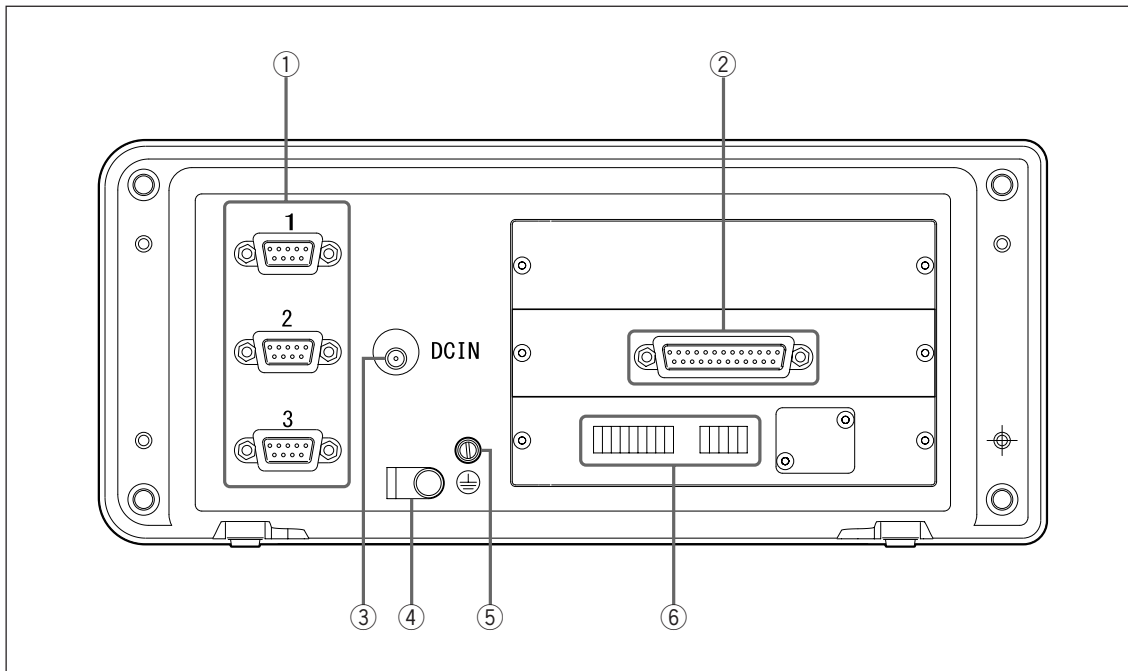

No.	Name	Function
①	Measuring unit input 1, 2, 3	Performs measuring unit input for first, second and third axes
②	RS-232C connector	RS-232C communication connector
③	DC input terminal	DC power input terminal Note Always use the specified AC adaptor (option). Using any other adaptor could damage the counter unit or cause it to malfunction.
④	AC adaptor cable clamp	Anchors the AC adaptor cable
⑤	Ground terminal	Note Use the included ground wire when setting up the counter unit, and always connect this terminal to the machine proper that you are setting up.
⑥	I/O counter unit connector	Performs various input/output of signals.

3. Installation and Connection

3-1. Installation

Environmental conditions

- Ambient temperature: 0 - 40 °C
- For indoor use (avoid exposure to direct sunlight)
- Install the counter unit so it is protected from coolant, machine oil, chips and the like
- Install the counter unit at least 50 cm from power switchboards, welders, motors and the like

Note

- Do not completely cover the counter unit with a vinyl cover or put it in a sealed case.
- If the counter unit's power is momentarily cut off, or if the voltage temporarily falls below the usable range, the alarm may sound and faulty operation may occur. If such a situation occurs, unplug the AC adaptor, wait a few seconds, reinsert the AC adaptor and repeat the operations from the beginning.

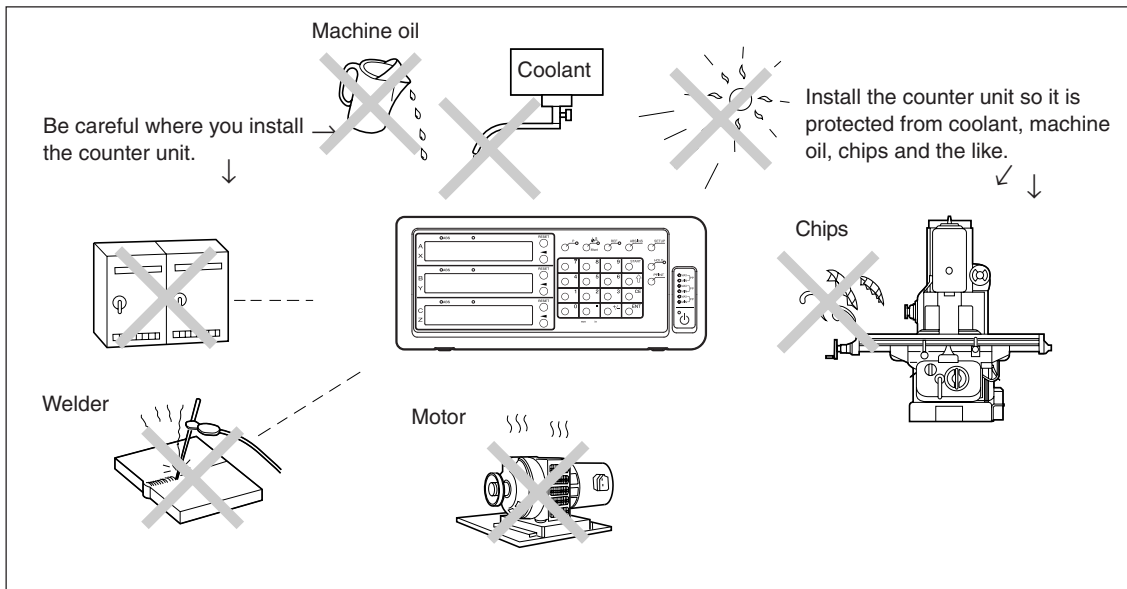

Panel cut-out diagram

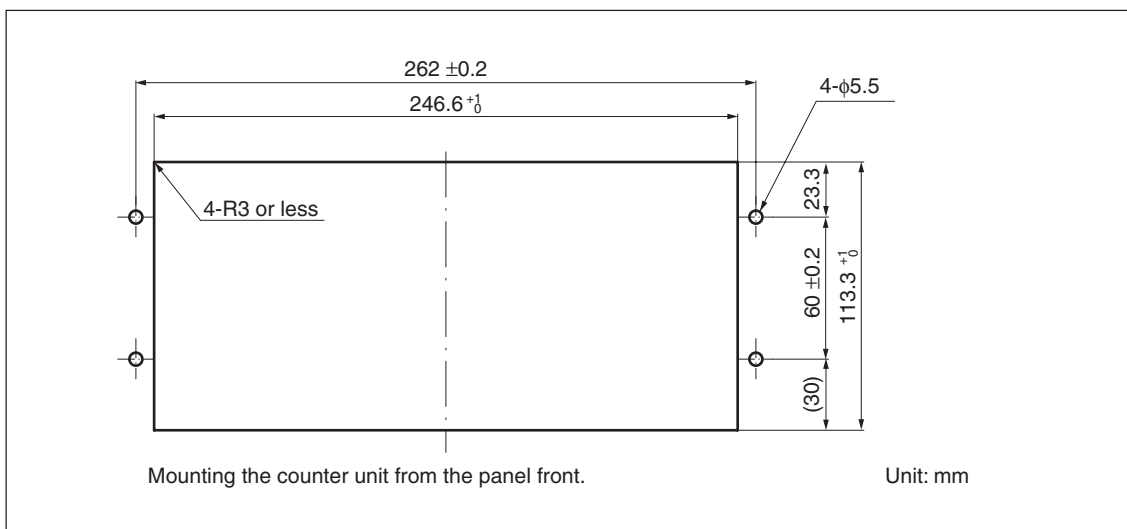

3-2. Connection

Be sure to provide power to the AC adaptor only after all other connections have been made.

Note

- Fasten the connecting cables to stable members to prevent accidental disconnection.
- Be sure to always turn off the AC power to the AC adaptor of the counter unit before connecting or disconnecting the measuring unit connector or replacing the measuring unit. Do not plug in or unplug the DC output connector on the counter unit side.
- Do not route connecting cables through the same duct as the machine power line.
- If securing the counter unit in place, secure it to the installed counter bracket.

Counter unit anchor bolts (supplied): M4 × 16 (2)

1 Secure the measuring unit.

2 Connect the measuring unit connector to the measuring unit input on the counter unit rear panel.
When using a measuring unit where the Z signal is not connected, connect the Z to +5 V and \overline{Z} to 0 V. If there is no Z signal connection, an error will be output over the RS-232C when a data request command is used.

3 Install the AC adaptor.

Note

Do not provide power to the AC adaptor in this step.

4 Remove the cable clamp on the counter unit rear panel.

5 Connect the DC output connector to the DC input terminal.

6 Attach the DC output connector cable to the cable clamp removed in step 5, and then secure it in place.

Note

Secure the cable so that excessive force is not applied to the connector.

7 Connect the ground wire.

8 Provide power to the AC adaptor.

<When power is turned on for the first time after factory shipping>

When the power is turned on for the first time, the basic settings must be made before use.
Proceed to "4. Settings".

<When the basic settings have already been completed>

LY is displayed on the connected displays (1 to 3).

After providing power, perform the basic settings (4-2) to allow operation.

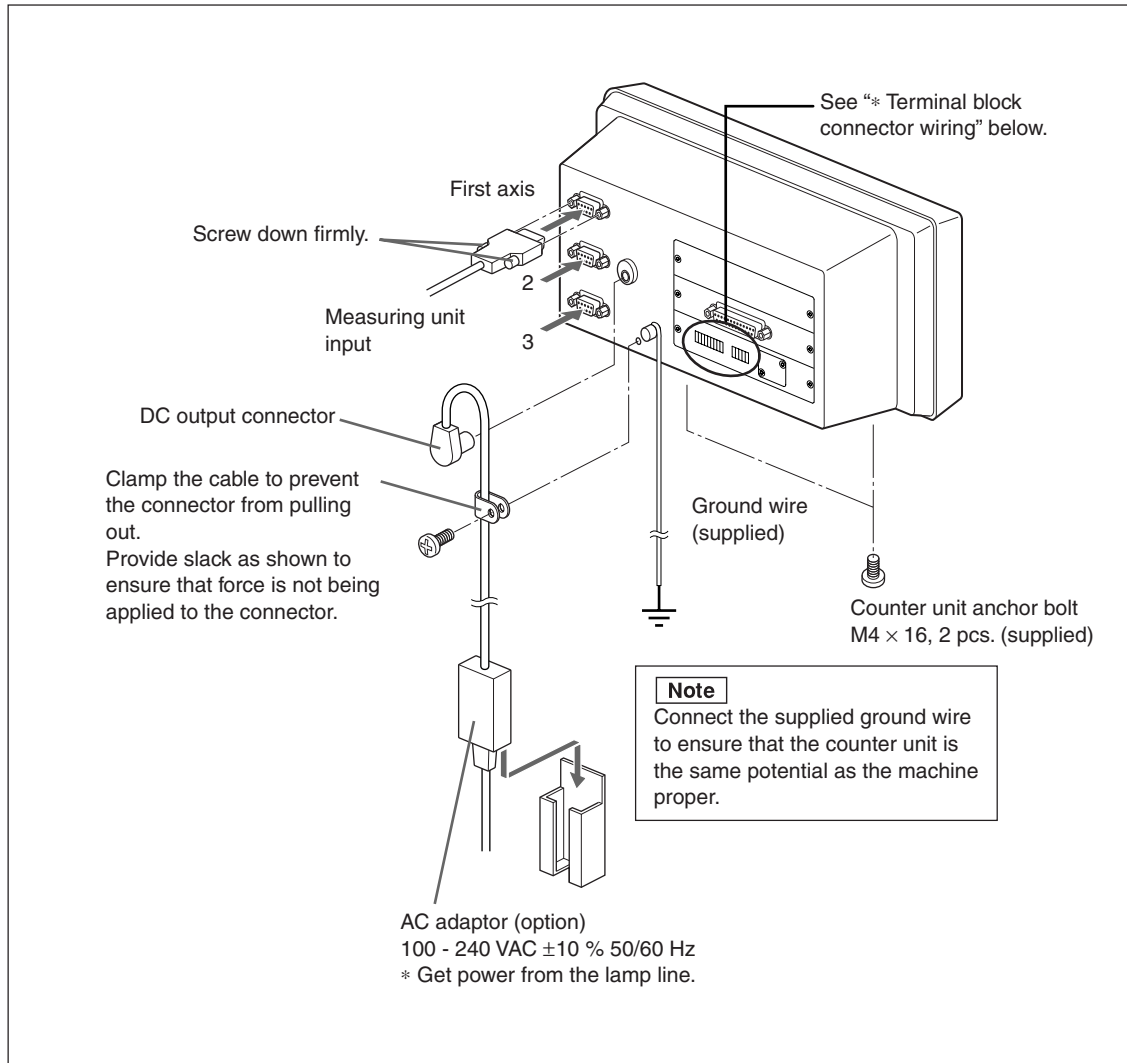

*** Terminal block connector wiring**

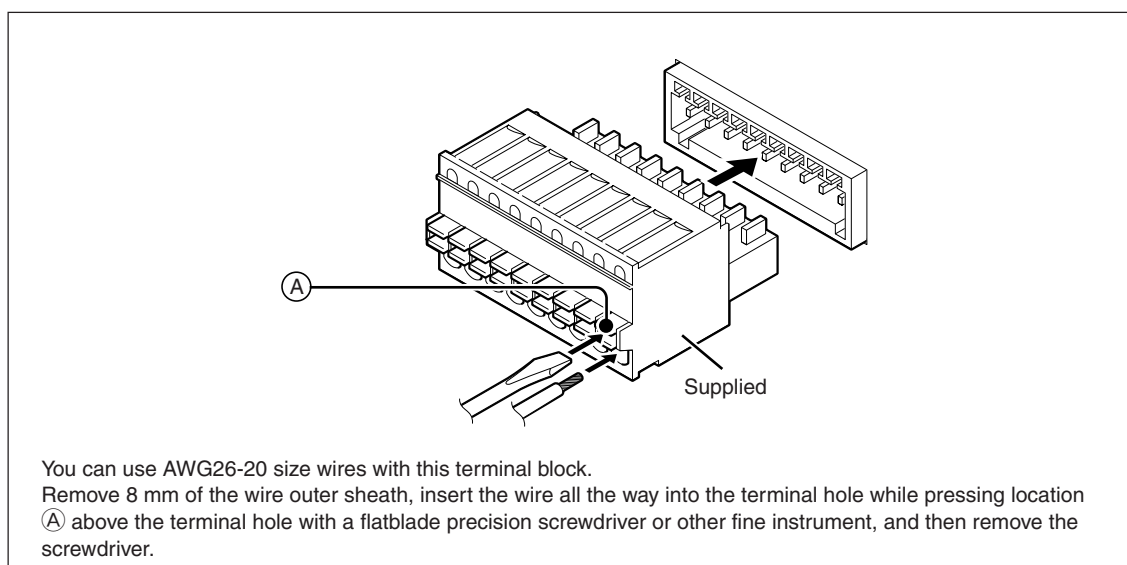

3-3. RS-232C Input and Output

Electrical Specifications

1) Driver side : Using MAX232 or equivalent product

Output voltage width	±5 V to ±10 V
Output resistance	300 Ω or more
Output short-circuit current	±10 mA

2) Receiver side : Using MAX232 or equivalent product

Input resistance	3 to 7 kΩ
Input allowable voltage	±30 V
Input threshold	Low 1.2 V, High 1.7 V

3) Input/output connector

Plug	DB-25P (JAE) or equivalent product
Receptacle	DB-25S (JAE) or equivalent product

4) Cable length

A cable length of no more than 15 m should be used.

A shielded cable should be used, and the shield must be connected to the connector housing.

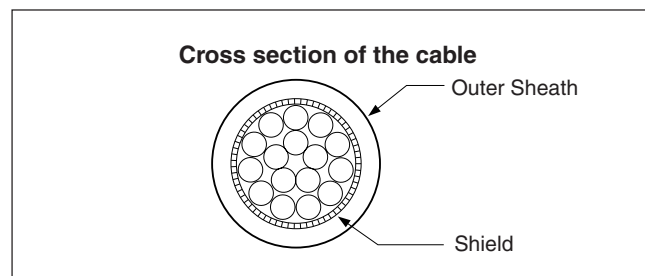

RS-232C Input/Output Connector

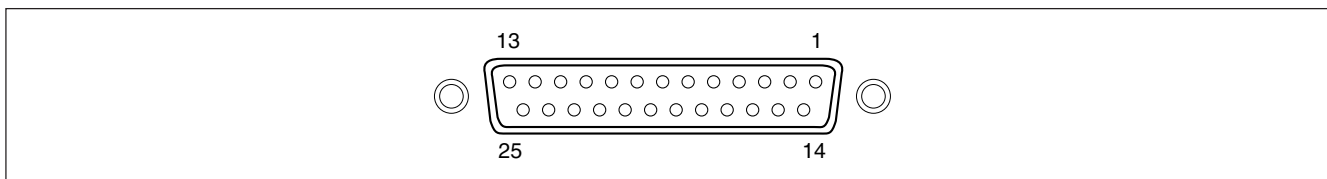

RS-232C connector on LY72

Pin No.	Signal	Abbreviation
1	Frame GND	FG
2	Received data	RXD
3	Transmit data	TXD
4	Clear to send	CTS
5	Transmission request	RTS
6	Pull up to +10 V	DTR
7	Signal GND	SG
8 to 25	—	NC

Connector on connected equipment side

Abbreviation
FG
TXD
RXD
RTS
CTS
DSR
SG
DTR

Note

- When TXD, RXD, FG and SG are connected, LY72 operates, but other wiring should also be carried out in accordance with the connected side (computer) specifications.
- Pin number 6 is pulled up to +10 V inside LY72.

4. Settings

You can use the LY72 after making the basic settings.

The basic settings determine the basic operation of the LY72, so be sure to make the basic settings after displaying the counter.

See “9-1. Setting Flowcharts” for the flow of setting operations.

4-1. Enabling Operation (When Using the LY72 for the First Time)

If you are unsure of the setting method described in “4-2. Making and Changing Basic Settings,” perform the procedure below. This will let you confirm the basic operation.

1 When the power is turned on, the display lights on in the order *SETUP* → *LABEL* (the axis label ABC lights on).

2 Press the \bigcirc^{ENT} key.
..... The display lights on in the order *MASTER* → *OFF*.

3 Press the \bigcirc^{ENT} key.
..... The display lights on in the order *SI* *IN* → *123* .

4 Press the \bigcirc^{ENT} key.
..... The display lights on in the order *COUNTRY* → *SD*.

5 Press the \bigcirc^{\uparrow} key.
..... The axis label flashes and settings can be changed.

Operation procedure (Starting settings)

If you press the \bigcirc^{\uparrow} key while the axis label is flashing, the setting contents display changes.

6 <When using other than inch units>

Proceed to step **7**.

<When using inch units>

Press \bigcirc^{\uparrow} one time.

The display lights on in the order *SD* → *US*.

STD Standard (mm display; inch display possible)

US U.S. (inch display; mm display possible)

JPN Japan (mm display only)

* Select the appropriate unit of measurement.

7 Press the \bigcirc^{ENT} key.
..... The setting is validated and the axis label lights on.

Operation procedure (Finalizing settings)

If you press the \bigcirc^{ENT} while the axis label is flashing, the set contents are validated and the axis label lights on.

8 Press the \bigcirc^{ENT} key again.

..... The display lights on in the order *SI* *RES* → *0.50* .

Operation procedure (To next item)

If you press the \bigcirc^{ENT} key after finalizing a setting, operation proceeds to the next setting item.

9 <When using a measuring unit with a resolution of 0.5 μm>

Press the \bigcirc^{ENT} key.

<When using a measuring unit with a resolution other than 0.5 μm>

(1) Press the \bigcirc^{ENT} key.

..... The axis label flashes and settings can be changed.

(2) Each time you press the \bigcirc^{ENT} key, the displayed setting contents (resolution) change. Press the \bigcirc^{ENT} key to display the resolution for the measuring unit to be used.

..... 0.5u → 0.1u → 00.10.00 (angle 10 minutes) → 00.01.00 (angle 1 minute) → 00.00.10 (angle 10 seconds) → 00.00.01 (angle 1 second) → 10u → 5u → 1u → 0.5u (repeat)

If the necessary resolution is not included in the above, press the \bigcirc^{START} key.

0.5u → 0.1u → 0.05u → 01.00.00 (angle 1 degree) → 00.10.00 (angle 10 minutes) → 00.01.00 (angle 1 minute) → 00.00.10 (angle 10 seconds) → 00.00.01 (angle 1 second) → 100u → 50u → 25u → 20u → 10u → 5u → 2u → 1u → 0.5u (repeat)

Referense

Press the \bigcirc^{START} key to increase the selectable options. Press the key again to return to the original options.

Press the \bigcirc^{ENT} key.

..... The settings are validated. The axis label lights on.

Operation procedure (Function expansion)

Press the \bigcirc^{START} key to increase the available selection options for setting items that have expanded selection options.

10 Press the \bigcirc^{ENT} key.

..... **CANCEL** is displayed. The axis label flashes.

11 Press the \bigcirc^{ENT} key.

..... **F IN ISH** is displayed.

12 Press the \bigcirc^{ENT} key.

..... **LY** is displayed. The axis label lights on.

This completes the basic settings.

After completing the basic settings, refer to “1. Basic Operation” in the Operating Manual and confirm the basic operation method. After confirming the basic operation, proceed to “4-2. Making and Changing Basic Settings.”

4-2. Making and Changing Basic Settings

Be sure to set the items that must be set before operation. If these settings are not made, you will be unable to use the counter unit.

After performing the procedure in “4-1. Enabling Operation,” make settings according to the actual application. See “9-1. Setting Flowcharts” for the flow of setting operations.





To enter the basic setting mode

- 1 Hold down the  key for 3 seconds or more while **LY** is displayed.

Basic settings

The basic settings include the items shown in the table on page 4-4. Be sure to set each item.

Operation keys

Setting item selection/ Setting content change	:  key	<ul style="list-style-type: none"> • When pressed once, the axis label flashes and setting contents can be changed. • When pressed in the change enabled status, the setting contents change.
Setting content finalization/ End item	:  key	<ul style="list-style-type: none"> • Press while the axis label is flashing to validate the setting contents. • Press after finalizing the setting contents to end that setting item and proceed to the next setting item.
Next item	:  key	<ul style="list-style-type: none"> • Press to proceed to the next setting item. • Press partway through the setting process to cancel the change contents and proceed to the next setting item.
Expanded selection options	:  key	<ul style="list-style-type: none"> • Press the  key while the axis label flashes to increase the available selection options for setting items that have expanded selection options. Press the key again to return to the original options.

Setting contents

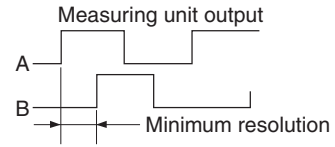
Display	Setting item	Available options	Remarks
<i>LABEL</i>	Axis label	<i>ABC</i> <i>XYZ</i>	A, B and C axes used as display axis labels and RS-232C commands. X, Y and Z axes used as display axis labels and RS-232C commands.
<i>MASTER</i>	Master calibration	<i>OFF</i> (Factory setting) <i>ON</i>	Master calibration function not used. Master calibration function used. * See "2-13. Master Calibration" in the Operating Manual.
<i>5 IG IN</i>	Input axis	<i>1</i> <i>1 2</i> <i>1 2 3</i> (Factory setting)	First axis only used. First and second axes used. First through third axes used.
<i>COUNTRY</i>	Destination country	<i>SG</i> (Factory setting) <i>US</i> <i>JPN</i>	Standard (mm display; inch display possible) U.S. (inch display; mm display possible) Japan (mm display only) * Select the appropriate unit of measurement.
<i>5 IG RES</i>	Measuring unit resolution	<i>0.5</i> (Factory setting) <i>0.1</i> : Linear scale 0.1 μm <i>0.5</i> : Linear scale 0.5 μm <i>1</i> : Linear scale 1 μm <i>5</i> : Linear scale 5 μm <i>10</i> : Linear scale 10 μm <i>00.00.01</i> : Rotary scale 1 s <i>00.00.10</i> : Rotary scale 10 s <i>00.01.00</i> : Rotary scale 1 min <i>00.10.00</i> : Rotary scale 10 min <Expanded selection options are shown below> <i>0.05</i> : Linear scale 0.05 μm <i>2</i> : Linear scale 2 μm <i>20</i> : Linear scale 20 μm <i>25</i> : Linear scale 25 μm <i>50</i> : Linear scale 50 μm <i>100</i> : Linear scale 100 μm <i>01.00.00</i> : Rotary scale 1 degree	Set to match the measuring unit resolution.  The displays for inputs 1, 2, and 3 of the measuring unit are fixed regardless of the settings for the display axis and display data at power ON (see "4-3. Advanced Settings"). Expanded selection options are made available by pressing the $\text{\textcircled{START}}$ key.

Completing the basic settings

- 1 After finalizing the measuring unit resolution setting, press the O^{ENT} key.
(Reference: You can complete the basic settings at any time by pressing the O^{SETUP} key. In this case only validated setting contents are applied to the settings.)
..... *CANCEL* is displayed.

Referense

To cancel all setting changes, press the O^{ENT} key while *CANCEL* is displayed.
The settings prior to making the changes are retained.

All clear (factory settings)

When you press the O^{REF} key while *CANCEL* is displayed, the display changes to *CLR*.
Press the O^{ENT} key to clear all the setting contents and return to the factory settings.
Press the O^{CE} key to cancel the all clear operation and return to the original display.

Note

When you perform the all clear operation, the advanced setting items also return to the factory settings. Be sure to write down any necessary contents before performing the all clear operation. Cleared contents cannot be restored.

- 2 Press the O^{REF} key.
..... *FINISH* is displayed.
- 3 Press the O^{ENT} key.
..... The settings are validated.

Note

The advanced setting items return to the factory settings after making the basic settings.

4-2-1. Axis label

The axis label lamps located to the left of the counter displays select whether to use ABC or XYZ.

ABC

- This is mainly used by gauge-type measuring units.
- The axis designation for RS-232C commands is ABC.

XYZ

- This is mainly used by scale-type measuring units.
- The axis designation for RS-232C commands is XYZ.
- Peak value (maximum value, minimum value, peak-to-peak value) calculations cannot be performed.
- The master calibration function cannot be selected.
- Timer output cannot be used with RS-232C.

4-2-2. Master calibration (When the axis label ABC is selected only)

When using a gauge-type measuring unit, an operation known as master calibration is sometimes performed when starting operation. The master calibration operation can be simplified if a gauge-type measuring unit with a reference point is used together with the master calibration function of this counter unit.

4-2-3. Input axis

This determines whether to use only one axis, two axes or three axes of the measuring unit.

4-2-4. Destination country

This selects the destination country.

STD Standard (mm display; inch display possible)

US U.S. (inch display; mm display possible)

JPN Japan (mm display only)

4-2-5. Measuring unit resolution

Set the resolution of the connected measuring unit.

Counter display A/X displays the first axis input, counter display B/Y displays the second axis input, and counter display C/Z displays the third axis input. When the resolution of the connected measuring unit cannot be found within the basic resolutions, press the  key to expand the available resolution options.

4-3. Advanced Settings









Make the advanced settings as necessary.

See “9-1. Setting Flowcharts” for the flow of setting operations.

To enter the advanced setting mode

Press the  key during count display.

Operation keys

Setting item selection/ Setting content change	:  key	<ul style="list-style-type: none"> • When pressed once, the axis label flashes and setting contents can be changed. • When pressed in the change enabled status, the setting contents change. • Numeric key input is possible for items that allow numerical value input.
Setting content finalization/ End item	:  key	<ul style="list-style-type: none"> • Press while the axis label is flashing to validate the setting contents. • Press after finalizing the setting contents to end that setting item and proceed to the next setting item.
Next item	:  key	<ul style="list-style-type: none"> • Press to proceed to the next setting item. • Press partway through the setting process to cancel the change contents and proceed to the next setting item.
Numerical value input	: Numeric keys ( ¹ to  ⁹ ,  , )	<ul style="list-style-type: none"> • Press to enter numerical values.
Expanded selection options	:  key	<ul style="list-style-type: none"> • Press the  key while the axis label flashes to increase the available selection options for setting items that have expanded selection options. Press the key again to return to the original options.

■ Setting contents (when axis label ABC is selected)

Display	Setting item	Available options	Remarks
<i>Pon dSP</i>	Display at power ON	<i>COUNT</i> <i>LY</i> (factory setting)	Count display after power ON <i>LY</i> display after power ON (used to detect power supply interruptions)
<i>dSP rES</i>	Display resolution and polarity	(Select polarity with $\ominus^{+/-}$ key) <i>0.1μ / 0.1μ</i> (ϕ lights on) <i>0.5μ / 0.5μ</i> (ϕ lights on) <i>1μ / 1μ</i> (ϕ lights on) <i>5μ / 5μ</i> (ϕ lights on) <i>10μ / 10μ</i> (ϕ lights on) <i>00.000 1</i> <i>00.00 10</i> <i>000 1.00</i> <i>00 10.00</i> <Expanded selection options are shown below> <i>0.05μ / 0.05μ</i> (ϕ lights on) <i>2μ / 2μ</i> (ϕ lights on) <i>20μ / 20μ</i> (ϕ lights on) <i>25μ / 25μ</i> (ϕ lights on) <i>50μ / 50μ</i> (ϕ lights on) <i>100μ / 100μ</i> (ϕ lights on) <i>0 100.00</i>	(Supports the selected polarity) 0.1 μ m / 0.1 μ m diameter display 0.5 μ m / 0.5 μ m diameter display 1 μ m / 1 μ m diameter display 5 μ m / 5 μ m diameter display 10 μ m / 10 μ m diameter display Angle 1 s Angle 10 s Angle 1 min Angle 10 min 0.05 μ m / 0.05 μ m diameter display 2 μ m / 2 μ m diameter display 20 μ m / 20 μ m diameter display 25 μ m / 25 μ m diameter display 50 μ m / 50 μ m diameter display 100 μ m / 100 μ m diameter display Angle 1 degree * The initial value is the same as the measuring unit resolution set by the basic settings.
<i>INPUT CHANGE</i>	Display axis, and display data at power ON	<i>1 Cr</i> (Factory setting) <i>2 Cr</i> (Factory setting) <i>3 Cr</i> (Factory setting) <input type="checkbox"/> <i>Cr</i> <input type="checkbox"/> <i>nAY</i> <input type="checkbox"/> <i>n 1n</i> <input type="checkbox"/> <i>P-P</i> (\square = 1 / 2 / 3)	Displays the current value of the first axis input Displays the current value of the second axis input Displays the current value of the third axis input Current value of \square axis Maximum value of \square axis Minimum value of \square axis Displays maximum value – minimum value * To turn off the display, set <i>- - -</i> . However, you cannot turn off all the counter displays at the same time.
<i>SCALING</i>	Scaling	<i>0.100000</i> to <i>9.999999</i> (Factory setting <i>1.000000</i>)	Numerically input the magnification.

(when axis label ABC is selected)

Display	Setting item	Available options	Remarks
<i>LInErr</i>	Linear compensation	<i>0</i> to ± 600 (Factory setting 0) <Expanded selection option> <i>0</i> to ± 1000	Numerically input the compensation value. (Unit: μm) * Numerical value of measuring unit resolution Example: When the measuring unit resolution is 0.001 mm, the compensation value applies to the three digits below the decimal point, and can be set in the range from -1.000 to 1.000.
<i>HOLD Fn</i>	Hold function	<i>LATCH</i> (Factory setting) <i>PAUSE</i>	Latch Pause
<i>INPUT</i>	General-purpose input	<i>Hold</i> (Factory setting) <i>Star</i> <i>dSP</i> <i>LOAD</i> <i>RECALL</i>	Hold input Restart input Display data switching Reference point load input Preset value call (preset recall)
<i>OUTPUT</i>	General-purpose output	<i>ALARn</i> (Factory setting) <i>dSP</i> <i>rEF</i> <i>r.AL</i>	Alarm Display data Reference point detected signal Reference point alarm
<i>KEYLOCK</i>	Key lock	<i>OFF</i> (Factory setting) <i>ON</i>	Keys unlocked Keys locked
<i>Star</i>	Current value store	<i>OFF</i> (Factory setting) <i>ON</i>	Current value not held Current value held
<i>FLICKER</i>	Flicker control	<i>OFF</i> <i>1</i> <i>2</i> (Factory setting)	Flicker control OFF Weak Strong
<i>SLEEP</i>	Sleep	<i>OFF</i> (Factory setting) <i>1</i> <i>5</i> <i>10</i> <i>30</i> <i>60</i>	Sleep mode OFF After 1 minute After 5 minutes After 10 minutes After 30 minutes After 60 minutes
<i>MODE</i>	Output data mode	<i>COMP</i> (Factory setting) <i>Print</i>	Computer mode ABC axis output Print mode A axis only output

(when axis label ABC is selected)

Display	Setting item	Available options	Remarks
FORn Only when Computer mode is selected	RS-232C data output format	AbC (Factory setting) AbC. h iAbC h iAbC.	Outputs all axes on the same line without a header Outputs each axis on a new line without a header Outputs all axes on the same line with any headers Outputs each axis on a new line with any headers
r dARA	Output data selection	Cr (Factory setting) nAY n iN P-P	Current value Maximum value Minimum value Peak-to-peak value
7 iNEr	Timer	OFF (Factory setting) 0.2 0.5 1 5 10 30 60 300	Automatic data output at fixed timer interval: OFF Automatic data output at fixed timer interval: 0.2 s Automatic data output at fixed timer interval: 0.5 s Automatic data output at fixed timer interval: 1 s Automatic data output at fixed timer interval: 5 s Automatic data output at fixed timer interval: 10 s Automatic data output at fixed timer interval: 30 s Automatic data output at fixed timer interval: 60 s Automatic data output at fixed timer interval: 300 s
bPS	Transfer rate	38400 19200 9600 (Factory setting) 4800 2400 1200	38400 bps 19200 bps 9600 bps 4800 bps 2400 bps 1200 bps
PAR 174	Parity	nOn (Factory setting) Odd EVEN	None Odd Even
570P	Stop bit	1-570P (Factory setting) 2-570P	1 stop bits 2 stop bits
LENG 7H	Data length	8-b 17 (Factory setting) 7-b 17	8 bits 7 bits

■ Setting contents (when axis label XYZ is selected)

Display	Setting item	Available options	Remarks
<i>Pon dSP</i>	Display at power ON	<i>COUNT</i> <i>LY</i> (factory setting)	Count display after power ON <i>LY</i> display after power ON (used to detect power supply interruptions)
<i>dSP RES</i>	Display resolution and polarity	(Select polarity with \odot / \ominus key) <i>0.1μ / 0.1μ</i> (ϕ lights on) <i>0.5μ / 0.5μ</i> (ϕ lights on) <i>1μ / 1μ</i> (ϕ lights on) <i>5μ / 5μ</i> (ϕ lights on) <i>10μ / 10μ</i> (ϕ lights on) <i>00.000.0</i> <i>00.00.10</i> <i>000.100</i> <i>00.10.00</i> <Expanded selection options are shown below> <i>0.05μ / 0.05μ</i> (ϕ lights on) <i>2μ / 2μ</i> (ϕ lights on) <i>20μ / 20μ</i> (ϕ lights on) <i>25μ / 25μ</i> (ϕ lights on) <i>50μ / 50μ</i> (ϕ lights on) <i>100μ / 100μ</i> (ϕ lights on) <i>0.100.00</i>	(Supports the selected polarity) 0.1 μ m / 0.1 μ m diameter display 0.5 μ m / 0.5 μ m diameter display 1 μ m / 1 μ m diameter display 5 μ m / 5 μ m diameter display 10 μ m / 10 μ m diameter display Angle 1 s Angle 10 s Angle 1 min Angle 10 min 0.05 μ m / 0.05 μ m diameter display 2 μ m / 2 μ m diameter display 20 μ m / 20 μ m diameter display 25 μ m / 25 μ m diameter display 50 μ m / 50 μ m diameter display 100 μ m / 100 μ m diameter display Angle 1 degree * The initial value is the same as the measuring unit resolution set by the basic settings.
<i>INPUT CHANGE</i>	Display axis	<i>1 Cr</i> (Factory setting X) <i>2 Cr</i> (Factory setting Y) <i>3 Cr</i> (Factory setting Z)	Displays the value of the first axis input Displays the value of the second axis input Displays the value of the third axis input * To turn off the display, set - - -. However, you cannot turn off all the counter displays at the same time.
<i>SCALING</i>	Scaling	<i>0.100000</i> to <i>9.999999</i> (Factory setting <i>1.000000</i>)	Numerically input the magnification.
<i>Lin Err</i>	Linear compensation	<i>0</i> to \pm <i>600</i> (Factory setting 0) <Expanded selection option> <i>0</i> to \pm <i>1000</i>	Numerically input the compensation value. (Unit: μ m) * Numerical value of measuring unit resolution Example: When the measuring unit resolution is 0.001 mm, the compensation value applies to the three digits below the decimal point, and can be set in the range from -1.000 to 1.000.

(when axis label XYZ is selected)

Display	Setting item	Available options	Remarks
<i>INPU7</i>	General-purpose input	<i>HoLd</i> (Factory setting) <i>LoAd</i> <i>rECALL</i>	Hold input Reference point load input Preset value call (preset recall)
<i>OU7PU7</i>	General-purpose output	<i>ALArñ</i> (Factory setting) <i>rEF</i> <i>r.AL</i>	Alarm Reference point detected signal Reference point alarm
<i>KEYLOCK</i>	Key lock	<i>OFF</i> (Factory setting) <i>ON</i>	Keys unlocked Keys locked
<i>St</i>	Current value store	<i>OFF</i> (Factory setting) <i>ON</i>	Current value not held Current value held
<i>FLICKER</i>	Flicker control	<i>OFF</i> <i>1</i> <i>2</i> (Factory setting)	Flicker control OFF Weak Strong
<i>SLEEP</i>	Sleep	<i>OFF</i> (Factory setting) <i>1</i> <i>5</i> <i>10</i> <i>30</i> <i>60</i>	Sleep mode OFF After 1 minute After 5 minutes After 10 minutes After 30 minutes After 60 minutes
<i>mOdE</i>	Output data mode	<i>CoMP</i> (Factory setting) <i>Prnt</i>	Computer mode XYZ axis output Print mode X axis only output
<i>FORñ</i> Only when Computer mode is selected	RS-232C data output format	<i>YYZ</i> <i>YYZ</i> <i>hYYZ</i> <i>hYYZ</i> <i>h2YYZ</i> (Factory setting) <i>h2YYZ</i>	Outputs all axes on the same line without a header Outputs each axis on a new line without a header Outputs all axes on the same line with any headers type 1 Outputs each axis on a new line with any headers type 1 Outputs all axes on the same line with any headers type 2 Outputs each axis on a new line with any headers type 2
<i>bPS</i>	Transfer rate	<i>38400</i> <i>19200</i> <i>9600</i> (Factory setting) <i>4800</i> <i>2400</i> <i>1200</i>	38400 bps 19200 bps 9600 bps 4800 bps 2400 bps 1200 bps
<i>PARITY</i>	Parity	<i>NON</i> (Factory setting) <i>Odd</i> <i>EVEN</i>	None Odd Even
<i>STOP</i>	Stop bit	<i>1-STOP</i> (Factory setting) <i>2-STOP</i>	1 stop bits 2 stop bits
<i>LENGTH</i>	Data length	<i>8-b 17</i> (Factory setting) <i>7-b 17</i>	8 bits 7 bits

4-3-1. Display at power ON

This sets the display mode when the power is turned on.

L Y display : This setting can be used as an alarm to indicate that power supply was interrupted.

Count display : This setting enables immediate use after the power is turned on. However, when the master calibration function is set, the counter unit waits to go past the reference point.

* You can also set the data format with RS-232C commands. (See “3. RS-232C Commands” in the Operating Manual.)

4-3-2. Display resolution and polarity

The initial value is the same as the measuring unit resolution set by the basic settings. When the measuring unit resolution is changed, the display resolution is also initialized to the same resolution.

Also set the display polarity when setting this item.

* You can also set the data format with RS-232C commands. (See “3. RS-232C Commands” in the Operating Manual.)

4-3-3. Display axis, and display data at power ON (When the axis label ABC is selected only)

You can set the axis (first axis input, second axis input, third axis input axis) displayed in each counter display (A/B/C) and the data (current value, maximum value, minimum value, peak-to-peak value (maximum value – minimum value)) displayed at power ON.

Factory settings

Counter display A: Current value of the first axis input

Counter display B: Current value of the second axis input

Counter display C: Current value of the third axis input

The contents set here become the display data at power ON.

Setting method

1 Press the $\overline{\text{O}}$ key of the counter display (A/B/C) to be set, and select the axis to be displayed.

\rightarrow **1** (First axis) \rightarrow **2** (Second axis) \rightarrow **3** (Third axis)

2 Press the O^{ENT} key.

3 Press the $\overline{\text{O}}$ key to select the data displayed at power ON.

\rightarrow **C** (Current value) \rightarrow **M** (Maximum value) \rightarrow **m** (Minimum value) \rightarrow
P-P (Maximum value - Minimum value)

4 Press the O^{ENT} key.

Changing the display data during operation (See “1-4. Switching the Display Data” in the Operating Manual.)

- Display data can be switched during the operation when the display data are from the same input axis. However, input axis whose data are displayed cannot be switched. When the display axis must be switched, make the change with the advanced settings.
 - Display data set by the advanced settings is displayed when the power is turned back on.
- * You can also set the data format with RS-232C commands. (See “3. RS-232C Commands” in the Operating Manual.)

4-3-4. Display data axis (when the axis label XYZ is selected only)

This sets the displayed axes.

You can display the current value of the first (or second or third) axis input in each counter display (X/Y/Z).

Factory settings

Counter display X: Current value of first axis input

Counter display Y: Current value of second axis input

Counter display Z: Current value of third axis input

Setting method

- 1 Press the  key of the counter display (X/Y/Z) to be set, and select the axis to be displayed.

 1 (First axis) → 2 (Second axis) → 3 (Third axis)

- 2 Press the  key.

* You can also set the data format with RS-232C commands. (See “3. RS-232C Commands” in the Operating Manual.)

4-3-5. Scaling

This changes the display dimension magnification. This is mainly used when measuring objects with different reduced scales or when taking die shrinkage into account for cutting.

Example 1. When measuring a 1/2 model as an equal magnification model

By setting 2.000000, the display changes by 2 mm for each 1 mm of movement.

Example 2. When cutting a die for a resin part with a resin molding shrinkage ratio of 0.95 %

A large die is cut in consideration of shrinkage, so the die dimension relative to the part dimension is 1/0.95. Therefore, a die can be cut with the part dimensions as is by setting 1.052631.

* You can also set the data format with RS-232C commands. (See “3. RS-232C Commands” in the Operating Manual.)

4-3-6. Linear compensation

Unlike gauge-type measuring units, scale-type measuring units experience dimensional error caused by sagging of the device to which the scale is attached. You can compensate this sagging by measuring the compensation value as outlined in “2-17-2 Linear compensation” of the Operating Manual, and setting that value.

- * You can also set the data format with RS-232C commands. (See “3. RS-232C Commands” in the Operating Manual.)

4-3-7. Hold function

When axis label ABC is selected

The hold function consists of a latch function and a pause function.

Latch : You can hold the display even while the measuring unit is moving. This is used to read the dimension at a particular point without stopping movement during measurement.

Pause : You can pause updating of the peak value calculation even while the measuring unit is moving. Data resulting from movement while paused is not reflected to the peak value calculation.

- * You can also set the data format with RS-232C commands. (See “3. RS-232C Commands” in the Operating Manual.)

When axis label XYZ is selected

The hold function is fixed to “Latch,” so this is not a setting item.

4-3-8. General-purpose input

You can perform operations by external contact point input instead of key operations.

Possible operations

- Hold
- Restart (When the axis label ABC is selected only)
- Display data switching (When the axis label ABC is selected only)
- Relocation of datum points using reference points (Reference point load) or relocation of master calibration value using reference points (Reference point load)
- Preset value call (preset recall)

IN-A	Counter display A	Hold, restart, display data switching, relocation of datum points and master calibration values using reference points, preset value call
IN-B	Counter display B	
IN-C	Counter display C	
Hold		Function ON at first input; function OFF at second input

- * You can also set the data format with RS-232C commands. (See “3. RS-232C Commands” in the Operating Manual.)

To enable use

Check the following circuits, then make the necessary wiring connections and input the signal.

Overview of external contact point inputs

Input circuit for external input signals

- When using external input, connect the signal to the external input terminal for 10 ms or more (common terminal). When inputting an external signal again, ensure an OFF time of 70 ms or more.
- Use a shielded cable for the connecting cable, and connect the shielding to the I/O connector shell. In addition, connect COM separately from the shielding. (The switches and shielded cable should be prepared separately by the customer.)

Input circuit for general-purpose input, external reset and external print

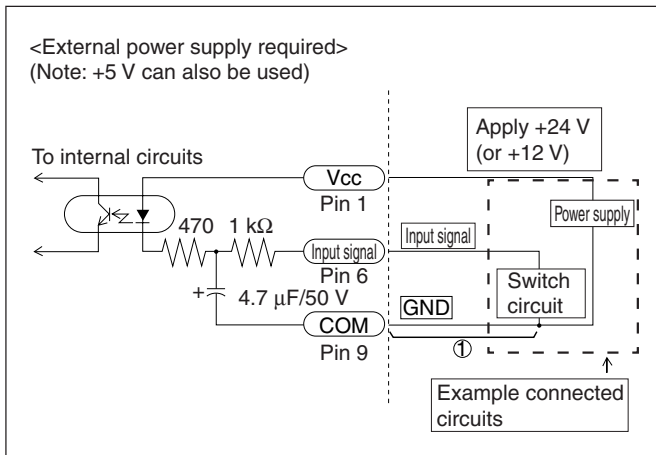

Input signal timing

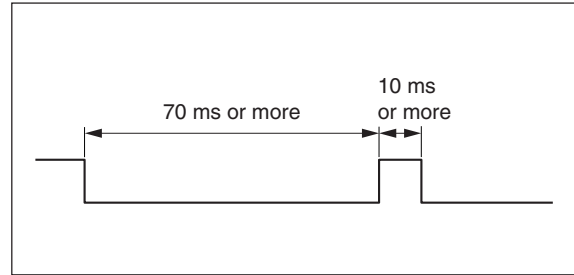

Input circuit delay time

When an input signal is input, the input circuit causes a delay time until that signal is transmitted to the internal circuits. Note that this delay time differs greatly according to the input circuit operating voltage. (Example) When operated at +24 V, the delay time until the signal is transmitted to the internal circuits is approximately 350 μ s.

The process time after the signal is transmitted to the internal circuits until operation is actually performed differs according to the operating conditions. When not using expansion units, this takes at least 5 ms (min.). This time becomes longer when expansion units are connected.

The delay time is greatly reduced by not connecting portion ① in the “Input circuit for general-purpose input, external reset and external print” circuit drawing above. However, in this case noise or other factors can easily cause misoperation. Therefore, be sure to take noise countermeasures when not connecting portion ①.

Reference

When ① is not connected

When using +24 V, the delay time is approximately 3 μ s.

Terminal block connector

Interface cable

Use a shielded cable such as that shown in the figure for the interface cable connected to the terminal block connector. Connect the shield to the casing near the terminal block connector. In addition, connect the COM terminal separately from the shield. (This cable should be prepared separately by the customer.)

Cable section

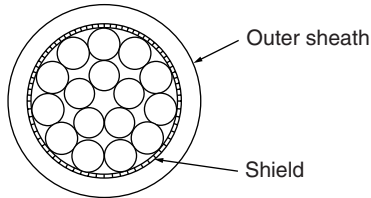

Input signal pin assignment

①	Power supply	Apply 12 - 24 V to the (Vcc) input.
②	External reset A, X	Ex. RESET A or Ex. RESET X
③	External reset B, Y	Ex. RESET B or Ex. RESET Y
④	External reset C, Z	Ex. RESET C or Ex. RESET Z
⑤	External print	Ex. PRINT
⑥	General-purpose input A	Ex. IN A or Ex. IN X
⑦	General-purpose input B	Ex. IN B or Ex. IN Y
⑧	General-purpose input C	Ex. IN C or Ex. IN Z
⑨	COM	COM

Terminal arrangement

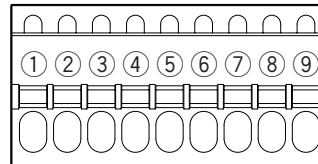

To enable use

Check the following circuit, and then make the necessary wiring connections.

- * You can also set the data format with RS-232C commands. (See “3. RS-232C Commands” in the Operating Manual.)

Output circuit

- Output circuit

All output signals are photocoupler outputs (12 V to 24 V 15 mA max.).

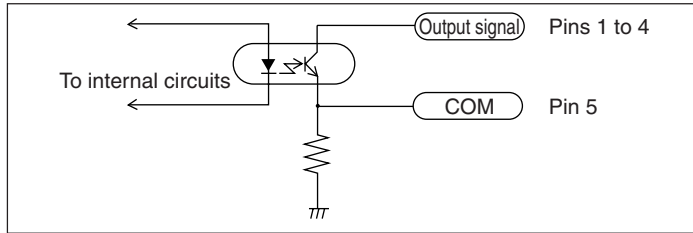

When using the general-purpose output as the reference point output, time until the output signal changes to High is 200 ms after going past the reference point.

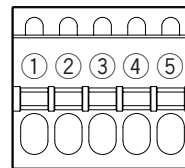

①	OUT AX
②	OUT BY
③	OUT CZ
④	—
⑤	COM

Terminal pin assign



4-3-10. Key lock

This function can be used to prevent unintended setting changes or misoperation after the counter unit is installed. For example, when the user differs from the person who installed the counter unit, the keys can be locked to prevent misoperation in the event the user incorrectly touches the keys.

After making the setting, the only valid key operations are the  (Standby) key and  key.

Canceling key lock

- * Once applied, a password must be entered to cancel the key lock.

- 1 Press  .
..... Password entry is required.
- 2 Press the numeric keys 1, 7, 9 and 3 in that order.
..... Advanced setting operations are enabled.
- 3 Set key lock to OFF in the advanced settings.

- * You can also set the data format with RS-232C commands. (See “3. RS-232C Commands” in the Operating Manual.)
However, password entry is not required when set by the RS-232C command.

4-3-11. Current value store

This sets whether to display the previous value when the power is turned on again.

Note

When using the master calibration function, a value is not displayed unless the measuring unit goes past a reference point, and so it will not function even if set to ON.

- * You can also set the data format with RS-232C commands. (See “3. RS-232C Commands” in the Operating Manual.)

4-3-12. Flicker control

If the number for the minimum digit of the display value is flickering and unstable, this flickering can be reduced.

Note

Because the flicker control is realized by averaging measured values, enabling flicker control could possibly affect the display response to some extent.

When using the flicker control function, if data is acquired at high speed over a RS-232C connection, the same data may be repeatedly output depending on the acquisition timing. If this occurs, use with the flicker control function set to OFF.

- * You can also set the data format with RS-232C commands. (See “3. RS-232C Commands” in the Operating Manual.)

4-3-13. Sleep

The display can be turned off automatically when the measuring unit is not moved and no key operations are performed for a certain period of time while the power is on. The display is restored whenever the measuring unit is moved or any key operation is made. The key operation at this time simply restores the display, and the normal key function is not performed. The display is restored even when the key lock is applied.

- * You can also set the data format with RS-232C commands. (See “3. RS-232C Commands” in the Operating Manual.)

4-3-14. Output data mode

This selects the mode of the data output when a data request command (“R” command) is received.

When you press the  key, the data designated by this setting is output.

4-3-15. RS-232C data output format (when Computer mode is selected by Output data mode only)

This sets the data format when outputting the data for all axes to a RS-232C device.

Press the  key to enable setting, and then press the  key to change the setting value.

- This sets if a header is used and the header type (software version 01.11 and later only).
 - * See P8-1 “Checking the software version number”.
- You can select output of all axes on the same line, or on a new line for each axis.

4-3-16. Output data selection (when axis the label ABC is selected only)

This sets the data output when the “R” command is input.
Current value, maximum value, minimum value, peak-to-peak value.

4-3-17. Timer (when the axis label ABC is selected only)

This function outputs the data designated by the “R” command (“4-3-16. Output data selection”) at a constant interval, even when the data request command is not input.

4-3-18. Transfer rate

This sets the RS-232C transfer rate.
You can select a rate between 1200 and 38400 (bps).

4-3-19. Parity

This sets the RS-232C parity.

4-3-20. Stop bit

This sets the RS-232C stop bit.

4-3-21. Data length

This sets the RS-232C data length.

5. Specifications

* Available only when axis label ABC is selected

Function		Description
Display		7 digits and minus display, Color amber
Display data	Display data at power ON	It is possible to set the display data for each axis at power ON.
	Display switching	The display data for each axis can be set by key operations.
		The calculation values for each axis can be selected and displayed in the counter displays A, B and C. (Advanced settings menu and key operations)
		Factory setting: Display A : First axis current value, Display B : Second axis current value, Display C : Third axis current value (Input axis switching is also possible)
Measuring unit input resolution		Standard : 0.1 μm , 0.5 μm , 1 μm , 5 μm , 10 μm , 1 s, 10 s, 1 min, 10 min Expanded : 100 μm , 50 μm , 25 μm , 20 μm , 2 μm , 0.05 μm and 1 degree can be added.
Display resolution		Measuring unit input resolution or higher and supported inch units Inch: Basic : 0.000005", 0.00001", 0.00005", 0.0002", 0.0005" Inch: Expanded: 0.000002", 0.0001", 0.001", 0.002", 0.005"
Input signal		A/B quadrature signal, Z signal (Conforms to EIA-422)
Minimum input phase difference		100 ns
Quantization error		± 1 count
Alarm display		Measuring unit disconnected, Excess speed, Maximum display amount exceeded, Power failure, Error in stored data
Reset	Key operation and external reset	Current value reset, Alarm cancel
Restart	START key and external input	Restart of peak value calculation for each axis/all axes
Preset	Preset/call by key operations, External recall	It is possible to store/edit up to three values for each axis.
* Master calibration function	In combination with a measuring unit with a reference point	The master calibration value is relocated when going past the reference point after the power is turned on.
Datum point operations	Datum point set/call by key operations	It is possible to store/edit one value for each axis (when not using the master calibration function).
Reference point operations	Reference point hold/relocation by key operations	It is possible to store/edit one value for each axis (when not using the master calibration function).
Hold function	Latch input when latch is selected by general-purpose input, and function operated by HOLD key	Selectable from latch and * pause Latch : Display held while latched (Display hold) Pause : Peak calculation stopped while paused (Peak calculation hold)
General-purpose input	Input connector	Phoenix Contact terminal block connector, 9 pins (Including external reset and external preset value call (preset recall))
		The function can be selected for inputs 1 to 3. Input 1 : (for axis A) Hold function (Latch, * Pause), * Restart, Display mode switching, External reference point load, External preset value call Input 2 : (for axis B) Hold function (Latch, * Pause), * Restart, Display mode switching, External reference point load, External preset value call Input 3 : (for axis C) Hold function (Latch, * Pause), * Restart, Display mode switching, External reference point load, External preset value call

5. Specifications



Function		Description
General-purpose output	Output connector	Phoenix Contact terminal block connector, 5 pins
		The function can be selected for outputs 1 to 3. Output 1: (for axis A) Alarm, * Display mode, Reference point detected signal, Reference point alarm Output 2: (for axis B) Alarm, * Display mode, Reference point detected signal, Reference point alarm Output 3: (for axis C) Alarm, * Display mode, Reference point detected signal, Reference point alarm
Linear compensation		A fixed compensation amount is applied to the measuring unit's count value. Compensation amount Standard: $\pm 600 \mu\text{m/m}$ (Expanded: $\pm 1000 \mu\text{m/m}$)
Scaling		Scaling factor: 0.100000 to 9.999999
Key lock		It is possible to set and cancel the key lock.
Current value store		It is possible to set whether to store the current value at power OFF.
Display at power ON		 display or count display can be selected.
Flicker control		When the minimum digit of the display value is unstable, the average value is displayed.
RS-232C		Data output format : All axes on same line/New line for each axis, header on/off and header type *Timer : OFF/0.2/0.5/1/5/10/30/60/300 seconds * Output data selection : Current value/Maximum value/Minimum value/Peak-to-peak value Transfer rate : 38400/19200/9600/4800/2400/1200 bps Parity : None / Odd / Even Stop bit : 1 or 2 Data length : 8 bits or 7 bits
Power save		The display is turned off when no operations are made for a preset time. (The time can be set.)
Power supply		DC 12 V Rating 0.75 A Max. 1 A AC 100 V - 240 V $\pm 10\%$ (When using the AC adaptor (option))
Power consumption		Max. 32 VA (connected to AC power supply)
Operating temperature range		0 to 40 °C (no condensation)
Storage temperature range		-20 to 60 °C (no condensation)
Mass		Approx. 1.5 kg

6. Dimensions

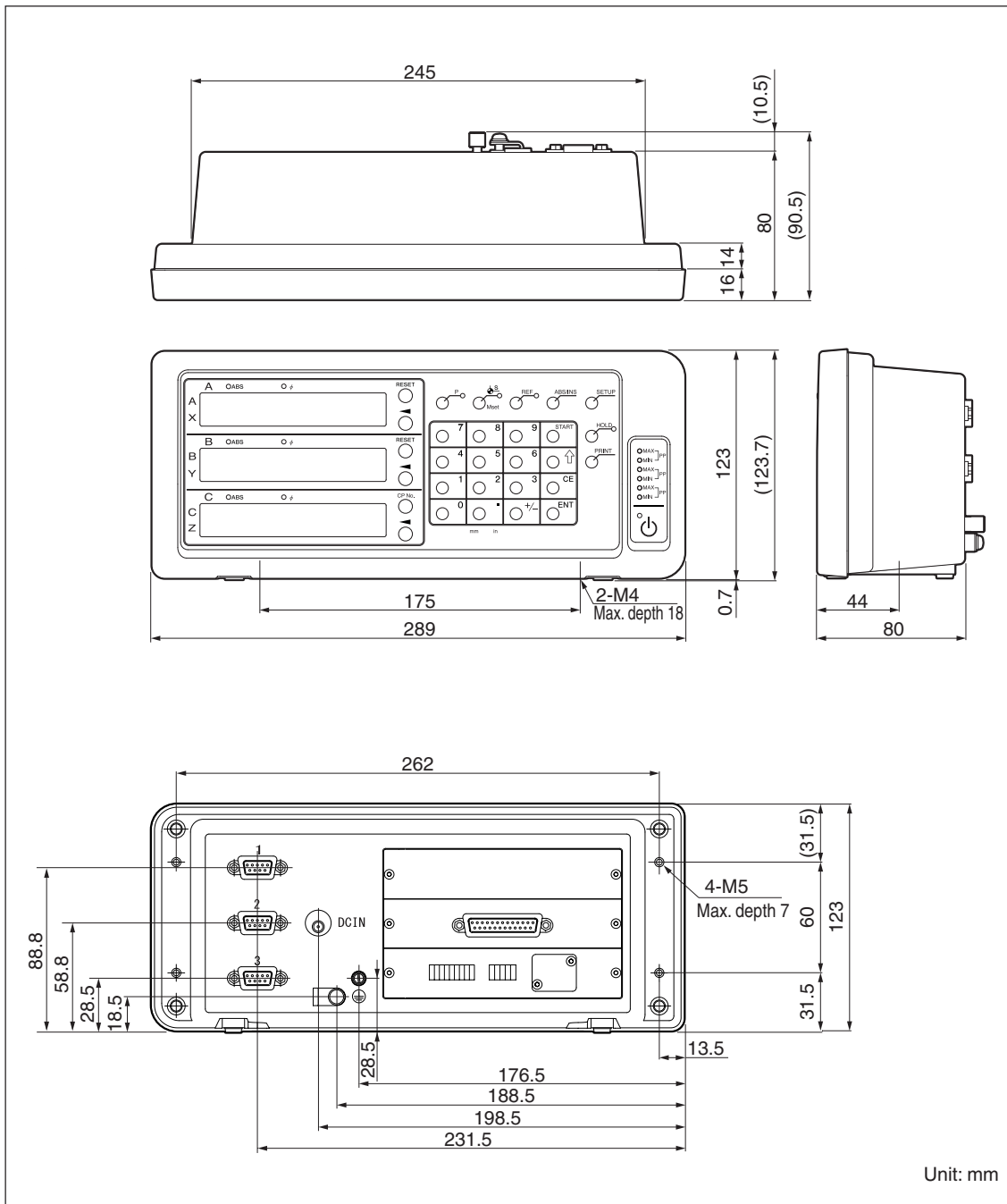
Specifications and appearances of the products are subject to change for improvement without prior notice.



7. Alarm Display

Display	Trouble	Causes/Remedy
<i>Error</i>	Measuring unit not connected	The measuring unit is not connected. Turn off the power, connect the measuring unit, and then turn on the power again. The display value is reset to zero.
<i>SPd Err</i>	Excess speed	The maximum response speed is exceeded at the measuring unit side. Perform resetting operation. (The same condition may occur when the machine is subjected to a major shock.)
<i>F000000</i>	Overflow	When the display has overflowed, an "F" is added to the highest digit. Use in a range where an "F" is not added.
<i>LY</i> (Lights on)	Power failure	The power fails momentarily during measurement. Perform resetting operation.
<i>LY</i>  (Flashing)	Error in stored data	The stored data has been changed by noise or other cause. Redo the settings starting from the basic settings. If this error is displayed frequently, the memory may be damaged. Contact your vendor.  : Error code (1 to 9, A to F)
<i>r.Error</i>	Error in reference point detection	This is displayed when a measuring unit without a reference point is connected or when the reference point signal wire in a measuring unit with a reference point is broken. Connect a measuring unit with a reference point. If this does not correct the problem, contact your vendor.

8. Troubleshooting

When the unit does not work properly, check the following before calling a Magnescale Co., Ltd. Representative for service.

<p>The power cannot be turned on. (Unstable power connection)</p>	⇒	<ul style="list-style-type: none"> • Disconnect the AC adaptor, and then reconnect after 1 to 2 minutes. • Check the connection and conduction of the power cord. • Check that the power voltage range is correct.
<p>L 5 is displayed (Alarm)</p>	⇒	<ul style="list-style-type: none"> • Check the connection and conduction of the power cord. • Check for high noise levels. (Try replacing with a normal axis.) • Disconnect the AC adaptor, and then reconnect after 1 to 2 minutes. • Perform resetting operation.
<p>Error is displayed (Alarm)</p>	⇒	<ul style="list-style-type: none"> • Check that the measuring unit signal connector is secured by screws. • Check that the conduit cable is not damaged or disconnected. • Check to see if the measuring unit has moved faster than the maximum response speed, or if there was a large vibration. • Check for high noise levels. (Try replacing with a normal axis.) • Disconnect the AC adaptor, and then reconnect after 1 to 2 minutes. • Perform resetting operation.
<p>No counting</p>	⇒	<ul style="list-style-type: none"> • Disconnect the AC adaptor, and then reconnect after 1 to 2 minutes. • Check to see if the measuring unit signal connector is loosely coupled. (Try replacing with a normal axis.)
<p>Erroneous counting (The unit sometimes miscounts)</p>	⇒	<ul style="list-style-type: none"> • Disconnect the AC adaptor, and then reconnect after 1 to 2 minutes. • Check to see if the measuring unit signal connector is loosely coupled. • Check that the ground wire is properly connected to the ground. Also check for rust or breakage. • Check that the power is in the specified range. (Use an automatic AC voltage regulator (AVR) to keep the power voltage within the specified range.) • Check that the unit is grounded correctly.
<p>Accuracy cannot be obtained</p>	⇒	<ul style="list-style-type: none"> • Check to see if the unit occasionally miscounts. • Check for any mechanical trouble that may affect accuracy. (Any trouble due to machine adjustment, sagging or play) • Check to see if there is a significant temperature difference between the measuring unit, machine and work.
<p>Cannot detect reference point</p>	⇒	<ul style="list-style-type: none"> • Check that the reference point detection position is correct. • Check that the reference point detection direction is correct.

When the cause of the above is known, take appropriate measures.

If you suspect a malfunction, check to see if the measuring unit has overrun or other problem has occurred, then check the software version and contact the service center.

Checking the software version number

- Power ON → L 5 → Press the  key → The version number is displayed.
HEr**. ** (**. **: version)
- Press any key. The display returns to L 5.

■ Cleaning

To clean the display and casing:

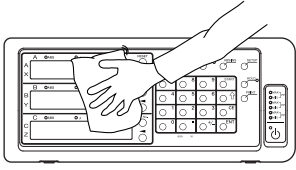

Wipe with a dry cotton cloth

To remove heavy dirt:



9. Supplement

9-1. Setting Flowcharts

9-1-1. Basic settings

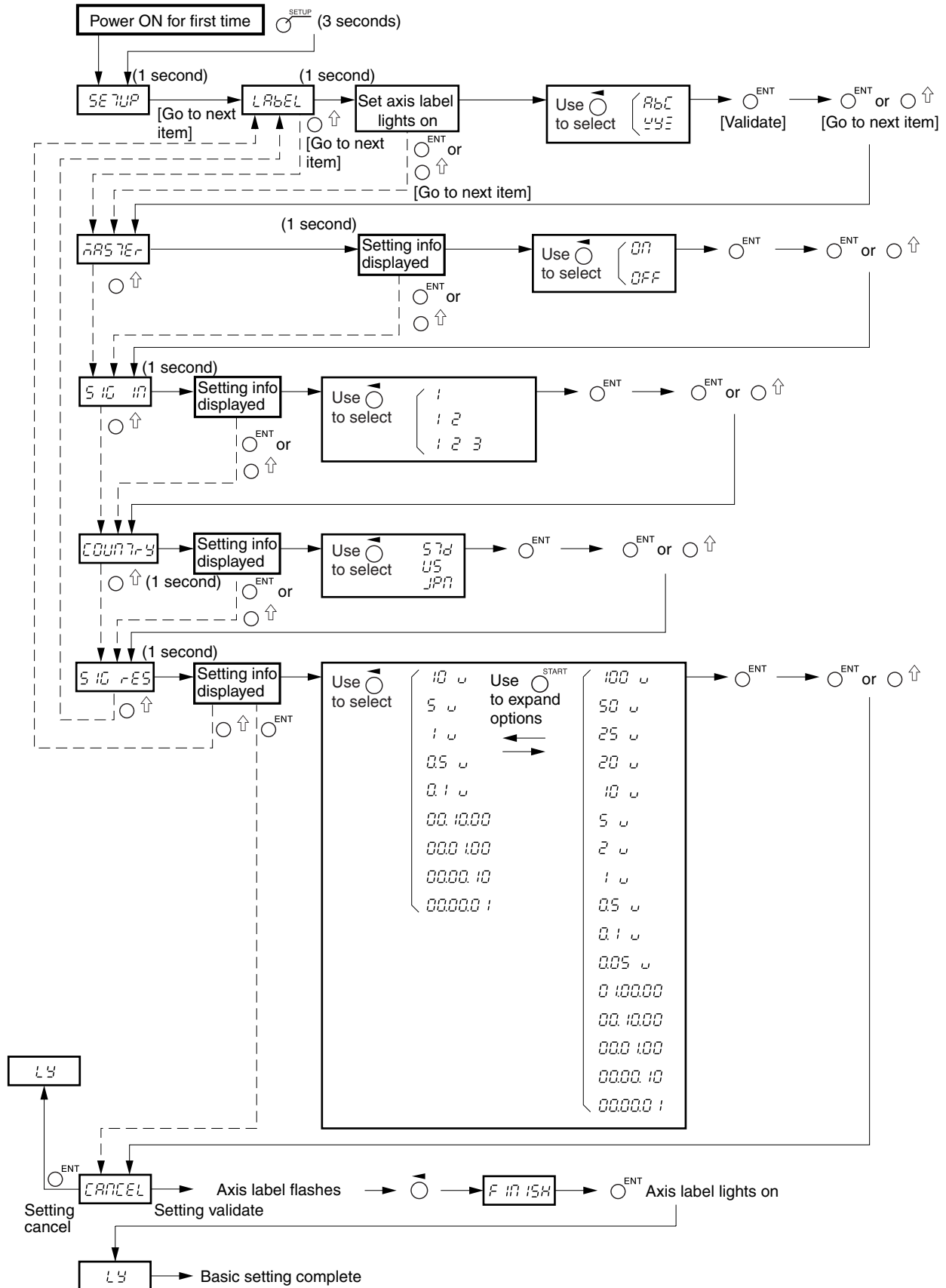

9-1-2. Advanced settings (When axis label ABC is selected)

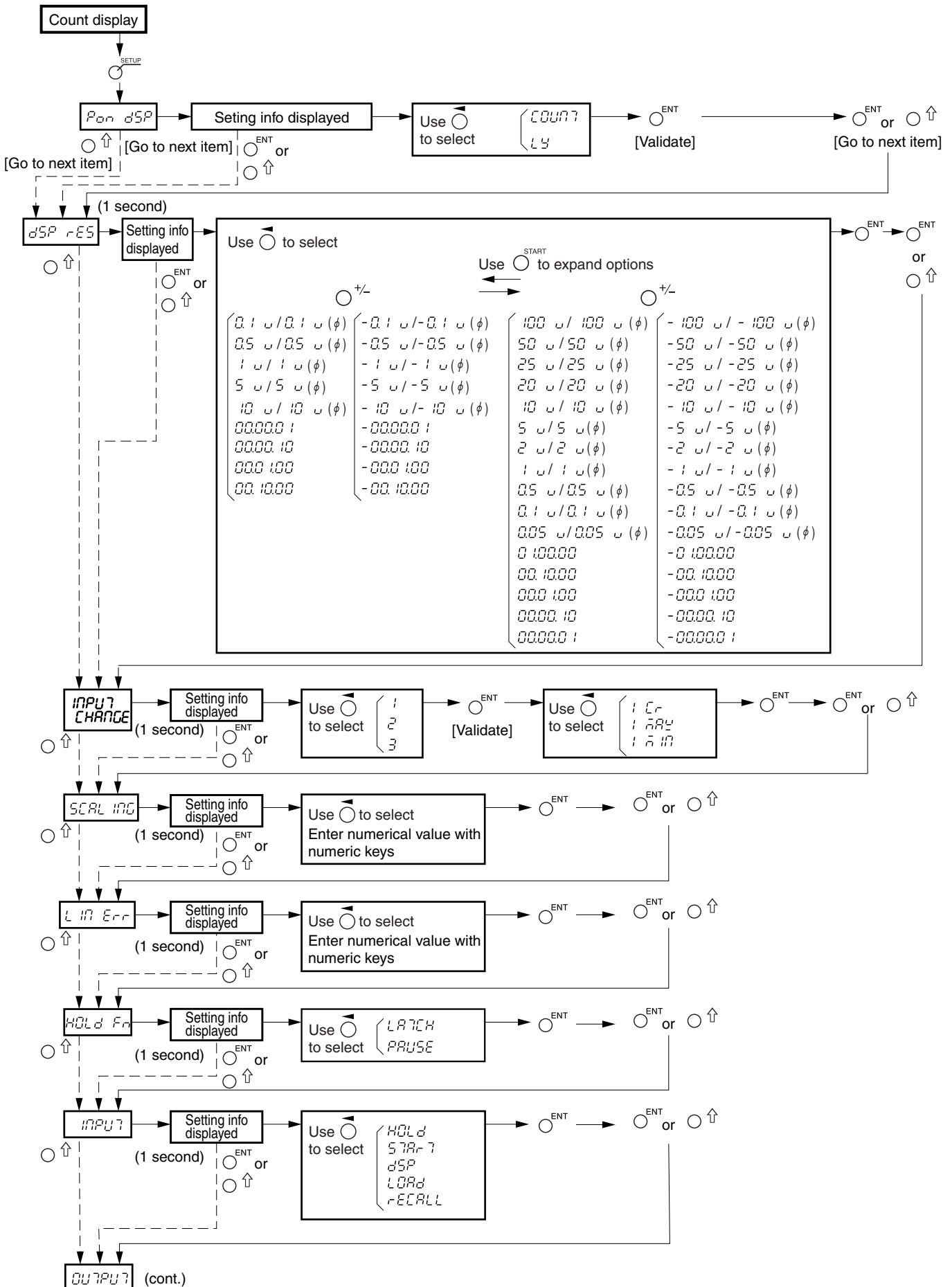

Advanced settings (When axis label ABC is selected)

(cont.)

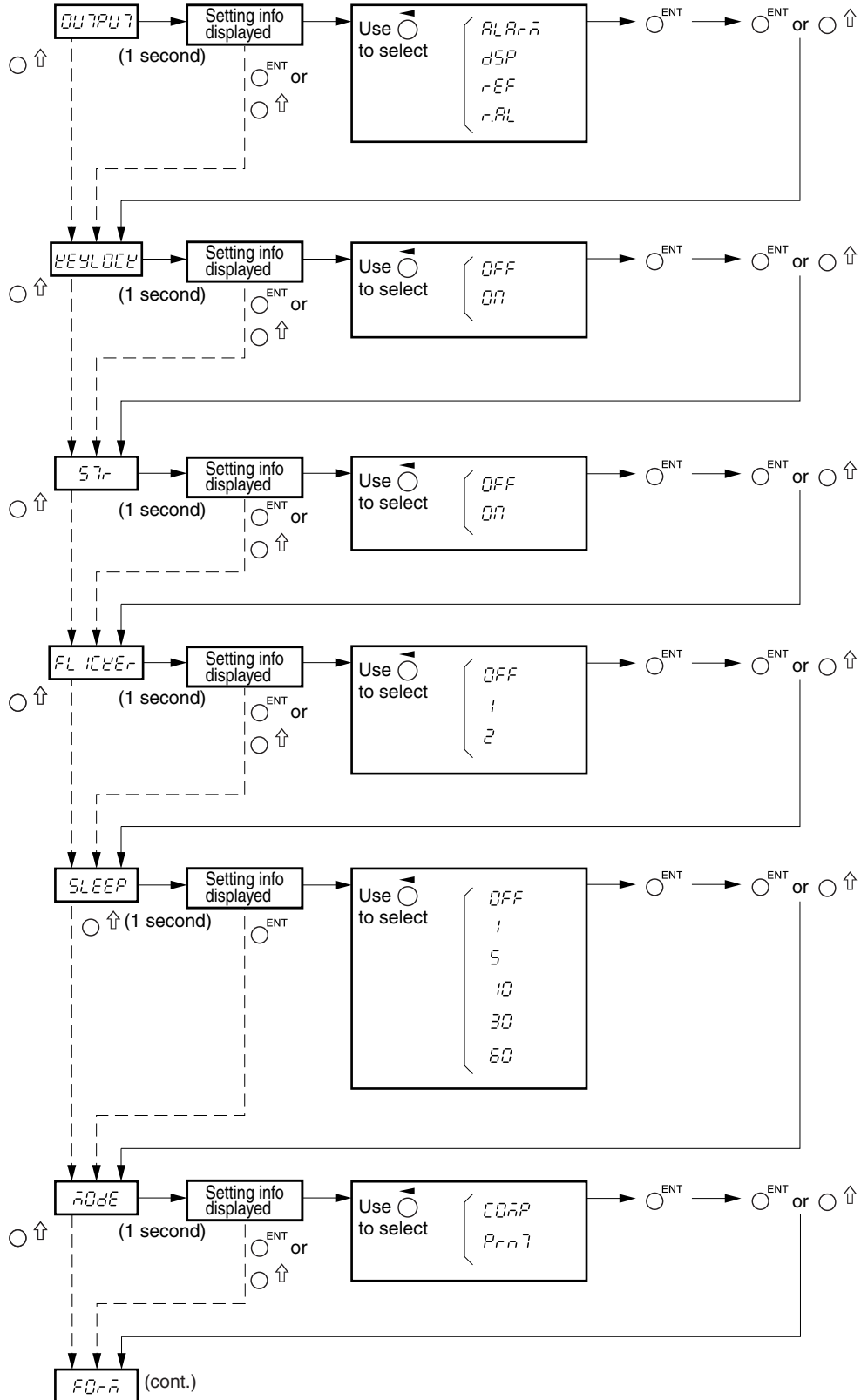

Advanced settings (When axis label ABC is selected)

(cont.)

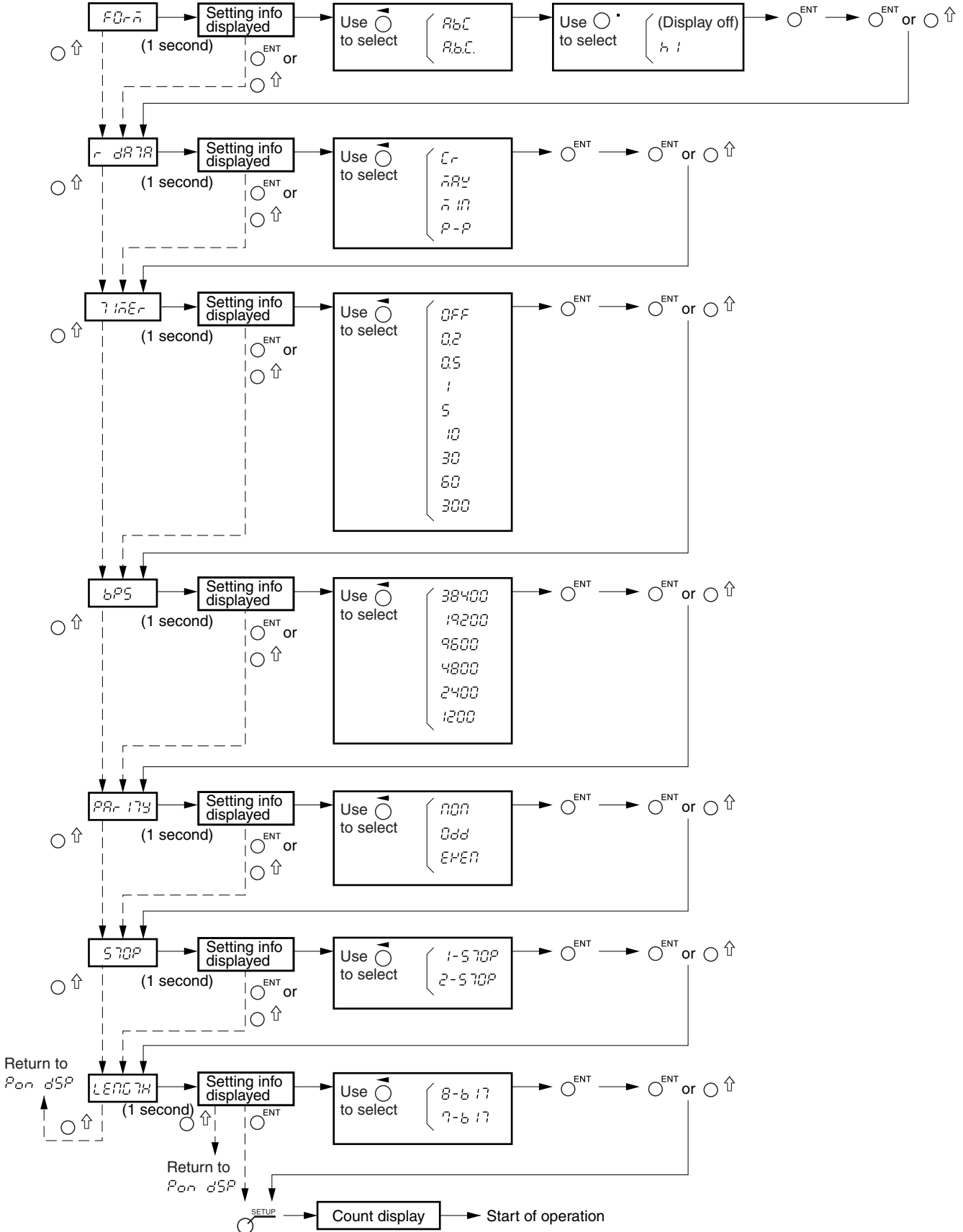

9-1-3. Advanced settings (When axis label XYZ is selected)

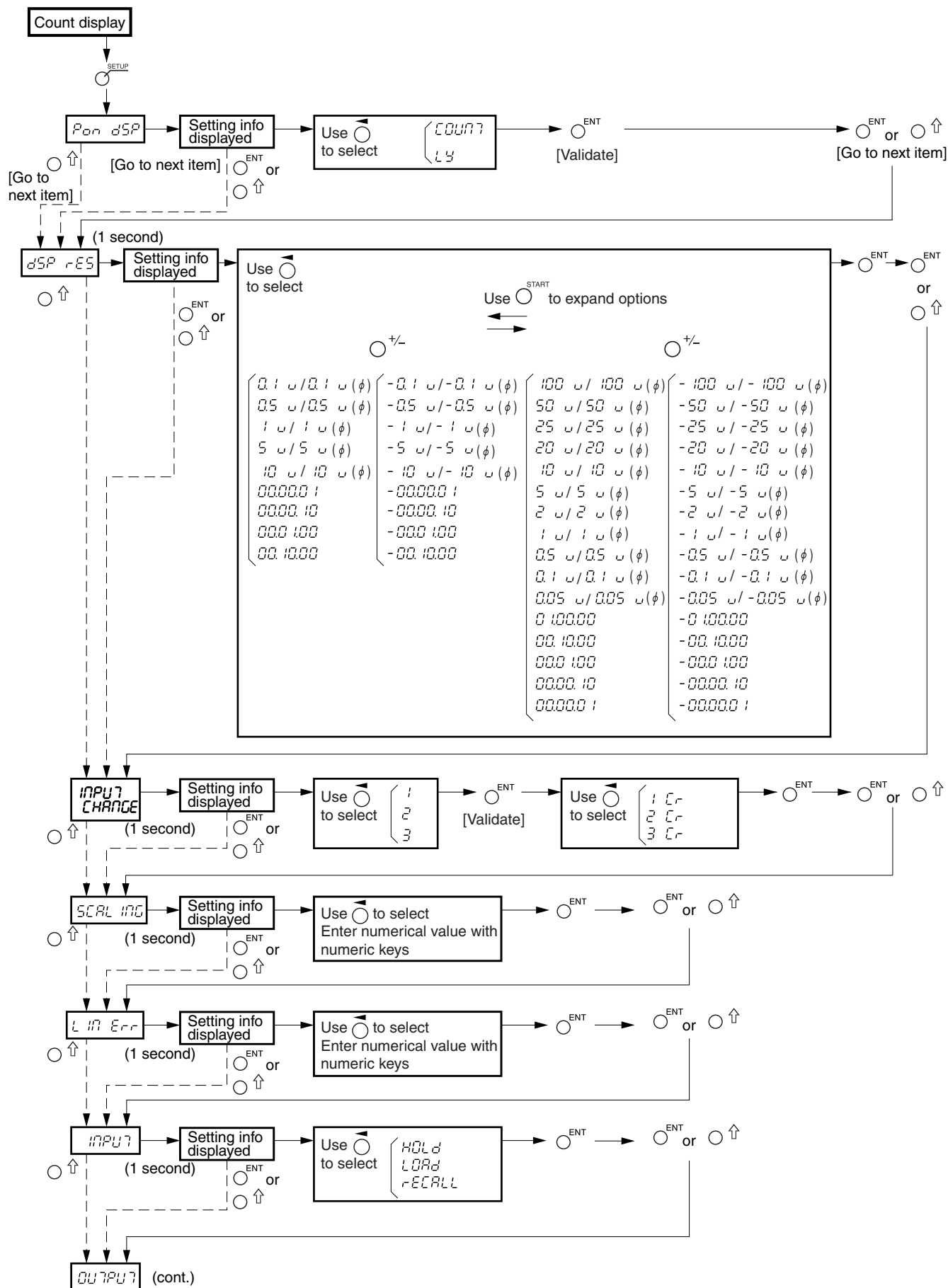

Advanced settings (When axis label XYZ is selected)

(cont.)

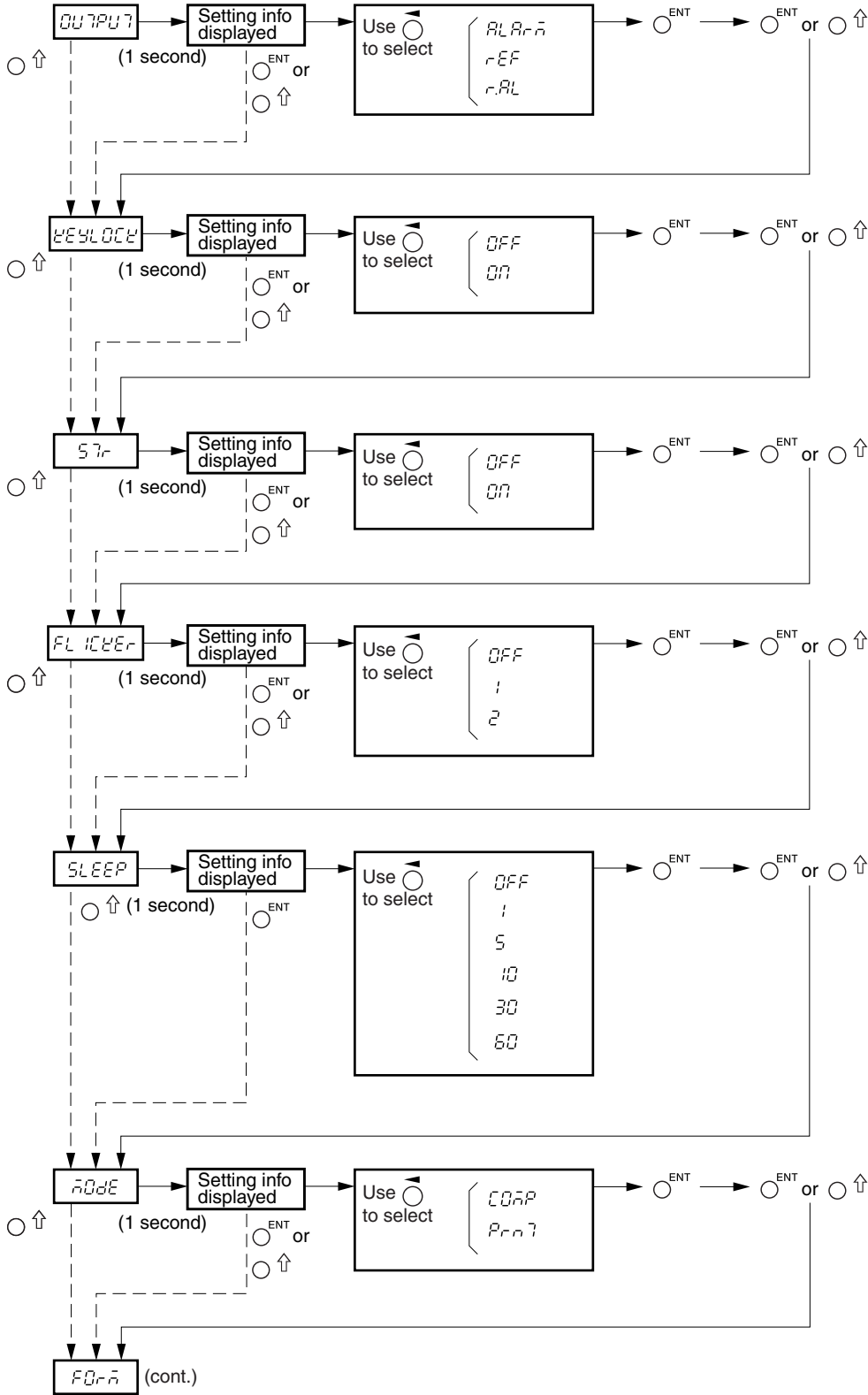





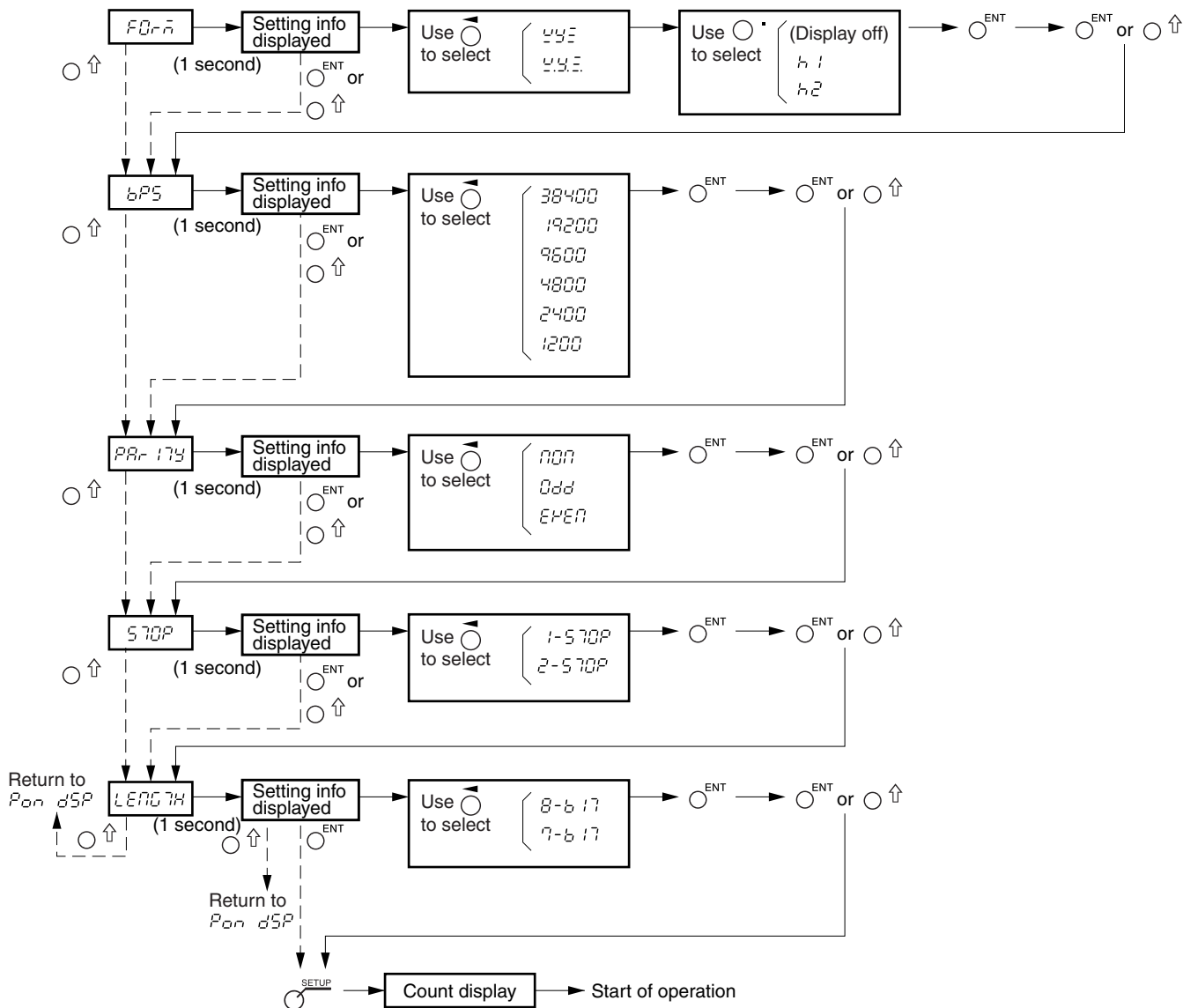









Advanced settings (When axis label XYZ is selected)

(cont.)



9-2. Key Operations

 RESET Reset key and external reset input	At power ON		 display → Count display: During restart operation, INC display (master calibration OFF) or when master calibration is ON, display waits to go past reference point. After going past reference point, display changes to count display.
	During count display	Count display axis	Each axis : INC = 0, ABS = unchanged, Peak value = 0
		Error display axis	Each axis : INC = 0, ABS = 0, Peak value = 0 However, when master calibration is ON, display waits to go past reference point.
 START Start key and external start input	At power ON		Operation prohibited
	During count display	Count display axis	Restarts peak value calculation for each axis/all axes.
		Error display axis	Operation prohibited
 ABS/INC ABS/INC display switching key	At power ON		Operation prohibited
	During count display	Count display axis	Switches each axis/all axes between ABS and INC display.
		Error display axis	Operation prohibited
 SETUP SETUP key	At power ON		Hold down to access basic settings.
	During count display		Accesses advanced settings.
 P Preset key	At power ON		Operation prohibited
	During count display		Preset lamp lights on and preset operation is enabled (= preset mode).
Axis select key, numeric key and ENT key/  key operation	Valid in preset mode		(Prohibited when datum point lamp or REF lamp is lit.)
	During count display	Count display axis	Up to three values can be stored/edited for each axis.
		Error display axis	Operation prohibited
External preset value call (preset recall input)	Valid even in other than preset mode		(Prohibited when datum point lamp or REF lamp is lit.)
	During count display	Count display axis	Calls the first preset value for each axis.
		Error display axis	Operation prohibited
 S Datum point key When not using master calibration function	At power ON		Version display
	During count display		Datum point lamp lights on and datum point operation is enabled (= datum point mode).
Axis select key, numeric key and ENT key operation	Valid in datum point mode		(Prohibited when preset lamp or REF lamp is lit.)
	During count display	Count display axis	The values for each axis can be stored/edited.
		Error display axis	Operation prohibited
 S Datum point key When using master calibration function	At power ON		Version display
	During count display		Datum point lamp lights on and master setting operation is enabled (= master setting mode).
Axis select key, numeric key and ENT key operation	Valid in master setting mode		(Prohibited when preset lamp or REF lamp is lit.)
	During count display	Count display axis	The values for each axis can be stored/edited.
		Error display axis	Operation prohibited

 REF key	When not using master calibration function	At power ON		Operation prohibited
		During count display		REF lamp lights on and reference point operation is enabled (= reference point mode)
Axis select key and ENT key operation		Valid in reference point mode		(Prohibited when preset lamp or datum point lamp is lit.)
		During count display	Count display axis	Reference point hold operation for each axis
			Error display axis	Operation prohibited
Axis select key, datum point key, numeric key and ENT key operation		Valid in reference point mode		(Prohibited when preset lamp or datum point lamp is lit.)
		During count display	Count display axis	Reference point load operation for each axis
			Error display axis	Operation prohibited
External reference point load input		Valid even in other than reference point mode		(Prohibited when preset lamp or datum point lamp is lit.)
		During count display	Count display axis	Reference point load operation for each axis
			Error display axis	Operation prohibited
 REF key	When using master calibration function	At power ON		Operation prohibited
		During count display		REF lamp lights on and reference point operation is enabled (= master relocation mode)
Axis select key and ENT key operation		Valid in master relocation mode is lit.)		(Prohibited when preset lamp or datum point lamp is lit.)
		During count display	Count display axis	Master calibration function started by reference point operation → After going past reference point, operation shifts automatically to datum point setting mode → Master calibration value stored by setting a datum point.
			Error display axis	Operation prohibited
 Hold key	Hold function	<input type="radio"/>	Select from latch and pause. Latch : Display held while latched (Display hold) Pause: Peak calculation stopped while paused (Peak calculation hold)	
 CE key		Cancels each input operation partway.		
 PRINT key		At power ON		Operation prohibited
		During count display		Data output designated by R command

このマニュアルに記載されている事柄の著作権は当社にあり、説明内容は機器購入者の使用を目的としています。したがって、当社の許可なしに無断で複写したり、説明内容(操作、保守など)と異なる目的で本マニュアルを使用することを禁止します。

本手册所记载的内容的版权归属Magnescale Co., Ltd., 仅供购买本手册中所记载设备的购买者使用。

除操作或维护本手册中所记载设备的用途以外, 未经 Magnescale Co., Ltd. 的明确书面许可, 严禁复制或使
用本手册的任何内容。

The material contained in this manual consists of information that is the property of Magnescale Co., Ltd. and is intended solely for use by the purchasers of the equipment described in this manual.

Magnescale Co., Ltd. expressly prohibits the duplication of any portion of this manual or the use thereof for any purpose other than the operation or maintenance of the equipment described in this manual without the express written permission of Magnescale Co., Ltd.

Le matériel contenu dans ce manuel consiste en informations qui sont la propriété de Magnescale Co., Ltd. et sont destinées exclusivement à l'usage des acquéreurs de l'équipement décrit dans ce manuel.

Magnescale Co., Ltd. interdit formellement la copie de quelque partie que ce soit de ce manuel ou son emploi pour tout autre but que des opérations ou entretiens de l'équipement à moins d'une permission écrite de Magnescale Co., Ltd.

Die in dieser Anleitung enthaltenen Informationen sind Eigentum von Magnescale Co., Ltd. und sind ausschließlich für den Gebrauch durch den Käufer der in dieser Anleitung beschriebenen Ausrüstung bestimmt.

Magnescale Co., Ltd. untersagt ausdrücklich die Vervielfältigung jeglicher Teile dieser Anleitung oder den Gebrauch derselben für irgendeinen anderen Zweck als die Bedienung oder Wartung der in dieser Anleitung beschriebenen Ausrüstung ohne ausdrückliche schriftliche Erlaubnis von Magnescale Co., Ltd.

日本からの輸出時における注意

本製品 (および技術) は輸出令別表第1の16の項 (外為令別表16の項) に該当します。キャッチオール規制による経済産業省の許可要否につきましては、輸出者様にてご確認ください。

For foreign customers

Note: This product (or technology) may be restricted by the government in your country. Please make sure that end-use, end user and country of destination of this product do not violate your local government regulation.

Magnescale Co., Ltd.

45 Suzukawa, Isehara-shi, Kanagawa 259-1146, Japan