

PH PH-100

High-precision, non-contact Magneswitch

Sensor
PH-100

Magnet
PG-104

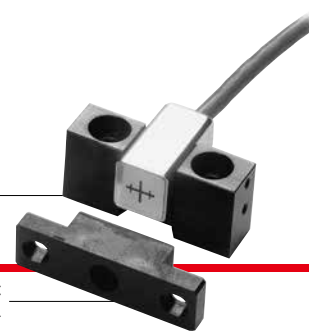

Magnescale

Magnesensor
Magneswitch

SPEED X PRECISION

Dimensions

Magnet
PG-104

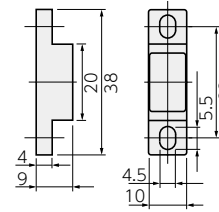

Sensor
PH-100

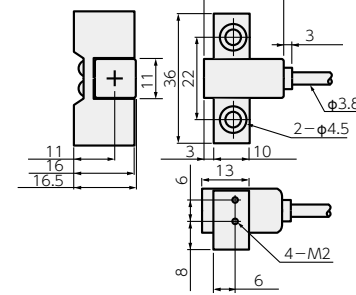

Unit: mm

- A combination of sensor PH-100 and magnet PG-104 that are connected to our interpolator can be used as a reference point for linear scales or rotary scales.
- Withstands extreme work conditions
- High precision: $\pm 1 \mu\text{m}$

Specifications

Model	PH-100
Repeatability	$\pm 1 \mu\text{m}$ (under same conditions)
Magnet	PG-104
Clearance	Max. 3 mm
Operating range	-10 °C to 50 °C
Detection direction	One direction
Cable length	3 m

We reserves the right to change product specifications without prior notice.

Accessory

Wiper PZ3 (for PK15/PK16)

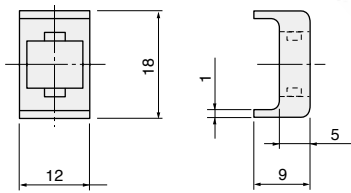
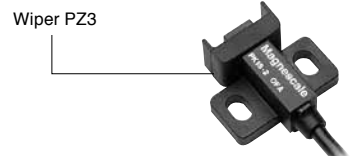

Unit: mm

Magnet mounting block PG-1 (for PG-10/PG-104)

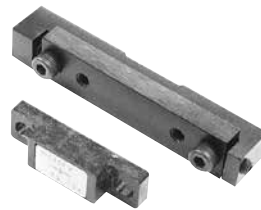

- Magnet (PG-104, PG-10) can be finely adjusted by $\pm 1 \text{ mm}$ in X direction.
- Very useful in setting a reference point

Wiper PH-1 (for PH-11, PH-100, or PH-500)

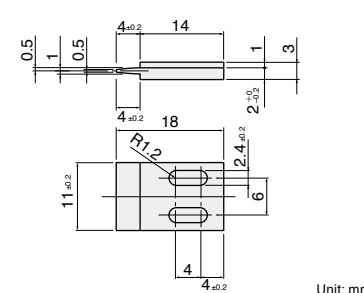
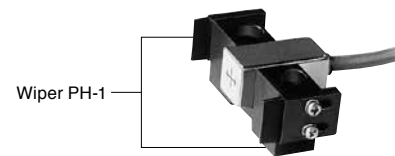

Unit: mm

PG-9010 (Magnet of PG-10)

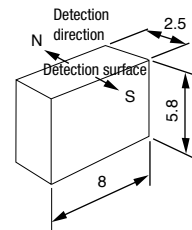

Unit: mm

CE15 Series extension cable for PK16

(Mini-DIN 6-pin plug ↔ mini-DIN 6-pin socket)

Model	Cable length
CE15 -3	3 m
-5	5 m
-10	10 m
-15	15 m
Compatible model	MJ100/110



Magnescale Co., Ltd.

International Sales Department	3-1-4 Edagawa, Koto-ku, Tokyo 135-0051, Japan	TEL.+81(0)3-6632-7924	FAX.+81(0)3-6632-7928	E-mail : info-mgs-eng@magnescale.com
Magnescale Americas Inc.	1 Technology Drive, Suite F217, Irvine, CA 92618, USA	TEL.+1(949)727-4017	FAX.+1(949)727-4047	E-mail : info-am@magnescale.com
Magnescale Europe GmbH	Antoniusstrasse 14, 73249 Wernau, Germany	TEL.+49(0)7153-934-291	FAX.+49(0)7153-934-299	E-mail : info-eu@magnescale.com
Service & Parts	45 Suzukawa, Isehara-shi, Kanagawa 259-1146, Japan	TEL.+81(0)463-92-2132	FAX.+81(0)463-92-3090	E-mail : info-css@magnescale.com

<http://www.magnescale.com>

MAGNESCALE, DIGIRULER, MAGNESENSOR and MAGNESWITCH are trademarks or registered trademarks of Magnescale Co., Ltd., Japan

The contents of this literature are as of Jan. 2020.

This catalog is printed with soy ink.

MAGNESENSOR_EA02C

C.2001.CB.100

For more information, please visit our website.

Magnescale Co., Ltd.

SET SET-B3/SET-K2

High-precision non-contact Magnesensor and Magneswitch

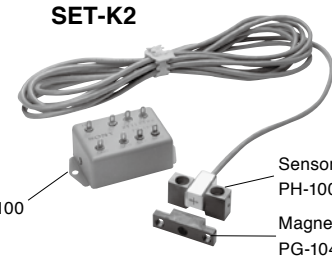
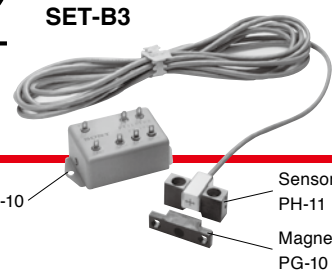

Dimensions

Magnet PG-10/PG-104

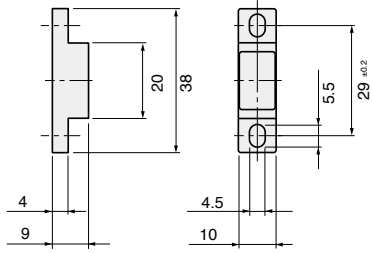

Sensor PH-11/PH-100

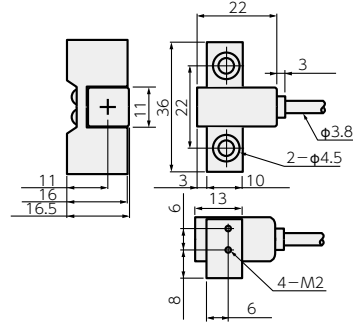

Detector PD-10

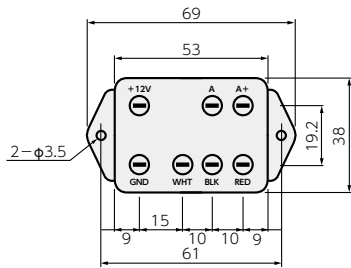

Detector PD-100

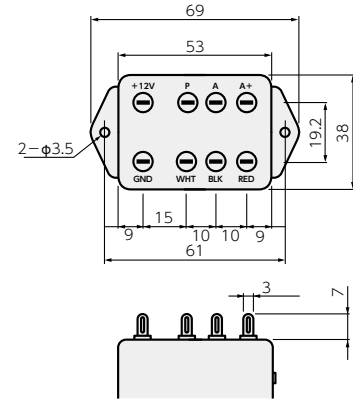

Unit: mm

- Magnesensor SET-B3 can be used as a reference point or to detect small displacements.
- Magneswitch SET-K2 can be used as a reference point for linear scales or rotary scales.
- Resistant to oil, dust, vibration, and impact and withstands extreme work conditions
- Compact and lightweight. Non-contact design
- Repeatability: $\pm 1 \mu\text{m}$
- Output signal: analog (SET-B3), pulse (SET-K2)
- Power supply: +12 V DC

Specifications

Model	SET-B3	SET-K2
Repeatability	$\pm 1 \mu\text{m}$ (under certain conditions)*1	
Operating range	—	$8 \pm 1 \text{ mm}$ (at 0.5 mm clearance)*4
Clearance	Max. 2.5 mm	Max. 3 mm
Max. response frequency	1.7 kHz*2	—
Max. delay	—	0.1 ms*2
Power supply	12V DC $\pm 5\%$	12V DC $\pm 10\%$
Current consumption	Max. 40 mA	Max. 20 mA
Output impedance	3 k Ω	12 k Ω
Temperature characteristics	0.3 $\mu\text{m}/^\circ\text{C}$ (zero drift)	0.8 $\mu\text{m}/^\circ\text{C}$ *5
Voltage characteristics	0.2 μm or less*% (zero drift)	8 $\mu\text{m}/\text{V}$
Protection grade	IP65 or equivalent for magnet/sensor, IP30 or equivalent for detector	
Operating temperature	-10 °C to 50 °C	
Cable length (sensor)	3 m (expandable up to 15 m by MSK-5000)*3	
Cable length (detector)	Max. 100 m by MSK-5100	Max. 20 m by MSK-5100

We reserves the right to change product specifications without prior notice.

Notes for items with * (Magnesensor SET-B3)

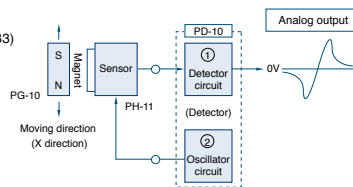

- *1 Repeatability Conditions for $\pm 1 \mu\text{m}$: temperature change within $\pm 1.2^\circ\text{C}$, voltage change within $\pm 0.12 \text{ V}$, clearance change $3 \mu\text{m}$ or less, and speed change 10 mm/s or less
- *2 Response speed Response frequency characteristics 1.7 kHz This is the input signal frequency where the relative output level drops by 3 dB in the response frequency characteristics. This causes the maximum response speed to be approx. 9 m/s if the standard magnet PG-10 (PG-9010) is used.
- *3 Cable extension Output voltage decreases approx. 2.3%/m by cable extension.

(Magneswitch SET-K2)

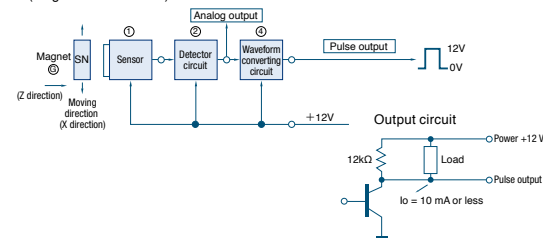

- *1 Repeatability This indicates the accuracy of the position at which the pulse output goes ON (at 0.5 mm clearance). Conditions for $\pm 1 \mu\text{m}$: temperature change within $\pm 1.2^\circ\text{C}$, voltage change within $\pm 0.12 \text{ V}$, clearance change $3 \mu\text{m}$ or less, and speed change 10 mm/s or less
- *2 Response speed This is a proper time constant of the detector circuit and indicates a max. delay (T) from detection to pulse output rise. The maximum response speed is L/T where L is a practically allowable detection tolerance. When the detector's proper time constant is taken into account in use, the time delay is negligible (e.g., the sensor and magnet are operated at the same speed). The detector element's maximum response speed is 10 MHz.
- *3 When extending the cable, check the noise caused by external equipment.
- *4 Clearance Clearance affects the operating range and repeatability.
- *5 Pay attention to the temperature characteristics.

Accuracy	1 μm	5 μm	10 μm
Max. response speed	10 mm/s	50 mm/s	100 mm/s

For position detection at the same speed, maximum speed change is caused.

SET SET-P15/-P16

High-precision, non-contact Magneswitch

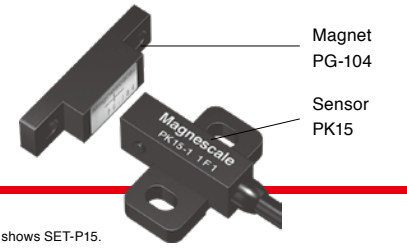

* Photo shows SET-P15.

Dimensions

SET-P15

Magnet PG-104

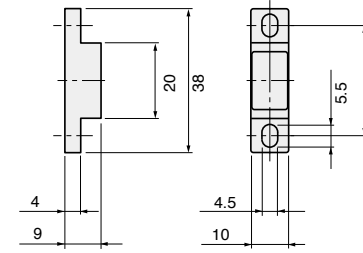

SET-P16

Magnet PG-104

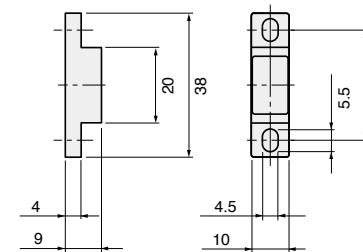

Sensor PK15

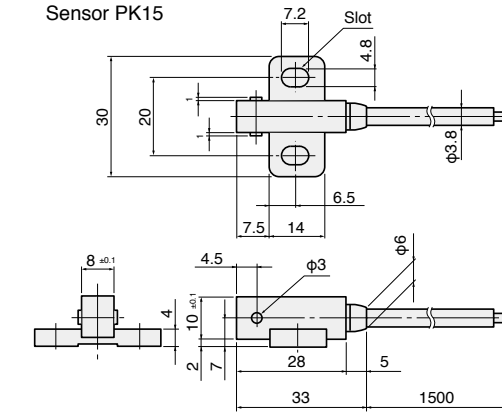

Sensor PK16

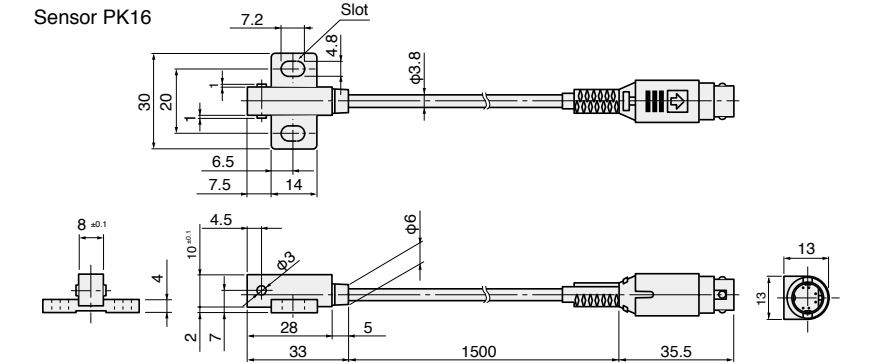

Unit: mm

- SET-P15 can be used as a reference point for DIGIRULER or as a limit switch.
- SET-P16 can be used as a reference point for DIGIRULER (interpolator MJ100/110 used in combination).
- Resistant to oil, dust, vibration, and impact and withstands extreme work conditions
- Repeatability: $\pm 3 \mu\text{m}$
- Max. response frequency: 10 kHz
- Built-in circuit for direct connection to a control unit
- Indication lamp (LED) for visual confirmation that the switching action is being made

Specifications

Model	PK15			PK16
	-1	-2	-3	-1
Repeatability	$\pm 3 \mu\text{m}$ (under certain conditions)*1			
Operating range	$7.5 \pm 2 \text{ mm}$ (at 1 mm clearance)			
Clearance	Max. 3 mm			
Max. response frequency	10 kHz			
Output	Circuit: NPN transistor, open collector			
	Operation: Turns ON in proximity			
	Contact capacity: Max. current 30 mA, max. voltage 30 V			
	Residual voltage: Residual voltage $V_{OL} = 0.4 \text{ V}$ or less at sink of 30 mA			
Protection circuit: Surge killer, protection against reverse polarity				
Indication lamp	Red LED turns ON when activated			
Power supply	5V DC $\pm 10\%$	12V DC $\pm 10\%$	24V DC $\pm 10\%$	5V DC $\pm 10\%$
Current consumption	Max. 10 mA			
Protection grade	IP67 or equivalent			
Insulation resistance	10 M Ω DC250 V*2			
Vibration resistance	49 m/s ² , 0 to 500 Hz			
Shock resistance	980 m/s ²			
Operating temperature	-10 °C to 60 °C			
Storage temperature	-20 °C to 80 °C			
Cable length	1.5 m (expandable up to 30 m)			

- *1 Repeatability This is unidirectional repeatability accuracy and indicates the accuracy of the position at which the reference point (stop) pulse output goes ON. Conditions for accuracy $\pm 3 \mu\text{m}$: temperature change within $\pm 1.2^\circ\text{C}$, voltage change within $\pm 1\%$ 5 min. after the power supply is turned ON, clearance variation 1 mm
- *2 Provided between molded plastic housing and circuit, and shielded wire and circuit

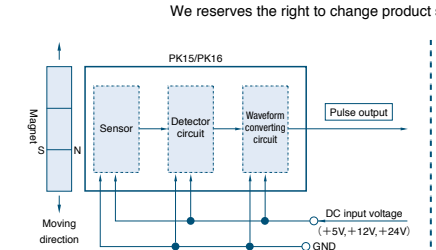

We reserves the right to change product specifications without prior notice.