

Magnescale

Comparetor Unit

LZ71-KR

Read all the instructions in the manual carefully before use and strictly follow them.
Keep the manual for future references.

Instruction Manual

[For U.S.A. and Canada]

THIS CLASS A DIGITAL DEVICE COMPLIES WITH PART15 OF THE FCC RULES AND THE CANADIAN ICES-003. OPERATION IS SUBJECT TO THE FOLLOWING TWO CONDITIONS.

- (1) THIS DEVICE MAY NOT CAUSE HARMFUL INTERFERENCE, AND
- (2) THIS DEVICE MUST ACCEPT ANY INTERFERENCE RECEIVED, INCLUDING INTERFERENCE THAT MAY CAUSE UNDERSIGNED OPERATION.

CET APPAREIL NUMÉRIQUE DE LA CLASSE A EST CONFORME À LA NORME NMB-003 DU CANADA.

[For the customers in Australia]

Australian EMC Notice

This product complies with the following Australian EMC standards.

- AS/NZS 4252.1 /94 EMC Generic Immunity Part1
- AS/NZS 2064 /92 Emission Standard for ISM Equipment

Safety Precautions

Magnescale Co., Ltd. products are designed in full consideration of safety. However, improper handling during operation or installation is dangerous and may lead to fire, electric shock or other accidents resulting in serious injury or death. In addition, these actions may also worsen machine performance.

Therefore, be sure to observe the following safety precautions in order to prevent these types of accidents, and to read these "Safety Precautions" before operating, installing, maintaining, inspecting, repairing or otherwise working on this unit.

Warning indication meanings

The following indications are used throughout this manual, and their contents should be understood before reading the text.

Warning

Failure to observe these precautions may lead to fire, electric shock or other accidents resulting in serious injury or death.

Caution

Failure to observe these precautions may lead to electric shock or other accidents resulting in injury or damage to surrounding objects.

Symbols requiring attention



CAUTION



FIRE



ELECTRICAL
SHOCK

Warning



Do not use the relay connector at voltages exceeding the specified voltage.

Do not use the relay connector with voltages in excess of the specified voltage

➔ **This may result in fire or electric shock.**



Do not use relay wires that exceed the rated capacity.

Use a relay wire with a temperature rating of 60°C or higher. Using a wire with a temperature rating of less than 60°C may result in fire.

➔ **This may result in fire.**



Don't handle the relay connector with wet hands.

Do not handle the relay connector with wet hands.

➔ **This may result in electric shock.**

Caution



Do not connect or disconnect the connectors with the power on.

Be sure to turn off the power before connecting or disconnecting power and signal connectors in order to prevent damage or misoperation.

Do not use in moving areas or areas exposed to strong shocks.

The unit does not have an earthquake-proof structure. Therefore, do not use the unit in moving areas or areas exposed to strong shocks.

➔ **This may result in electric shock.**

Contents

INSTALLATION

1. Before Operation	1-1
1-1. Precautions	1-1
1-2. Item List	1-1
1-3. Features	1-2
2. Name and Function of Each Part	2-1
3. Installation and Connection	3-1
3-1. Installing the Expansion Unit	3-1
3-1-1. LZ71-KR	3-1
3-2. Connecting the Output Connector	3-2
3-2-1. Open collector output type	3-2
3-2-2. Relay output type	3-3
3-2-3. Comparator setting value switching input	3-4
4. Settings	4-1
4-1. Advanced Settings	4-1
4-1-1. Output mode	4-1
4-1-2. Judgment target	4-1
4-1-3. Display switching	4-2

OPERATION

5. Functions	5-1
5-1. Comparator function	5-1
5-2. Positioning function	5-1
5-3. Switching between 16 sets of data	5-1
5-4. Latch	5-1
5-5. Display switching	5-2
5-5-1. When display switching is set automatically	5-2
5-5-2. When display switching is set to manual	5-4
6. Operation	6-1
6-1. Selecting the comparator set	6-1
6-2. Inputting and changing comparator setting values	6-1
7. Description of Operation	7-1
7-1. Comparator Function	7-1
7-2. Positioning Function	7-1
8. Troubleshooting	8-1
9. Specifications	9-1
10. Dimensions	10-1

INSTALLATION

Be sure to read this section before use.

1. Before Operation

Thank you for purchasing this Magnescale Co., Ltd. product.

Read this instruction manual through carefully before use, and keep it properly for future references. In particular, the contents of “3. Installation and Connection” are especially important for ensuring proper operation. Be sure to read this section and make sure the expansion unit is installed correctly before use. This instruction manual mainly explains the differences when the expansion unit is added to the LY71 counter unit. For other contents, see the LY71 instruction manual.

1-1. Precautions

This expansion unit is designed for use connected with the LY71, and requires the same handling cautions as when the LY71 is used alone.

See the LY71 instruction manual for the various cautions.

1-2. Item List

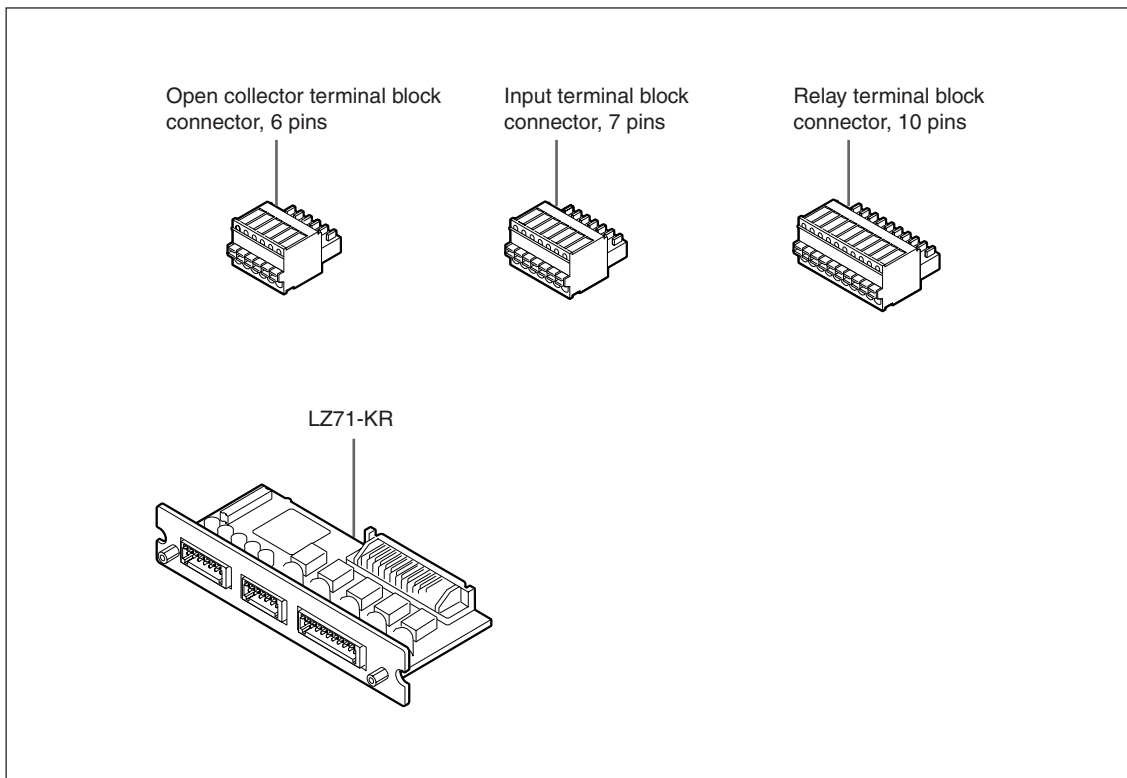

1-3. Features

The functions of your current LY71 counter unit can be expanded simply by inserting the expansion unit into the LY71.

Comparator function for various data

In addition to the current value, the maximum, minimum and peak-to-peak values can be compared with the comparator setting values and the judgment results output for use as control signals by PLC (Programmable Logic Controller) and other devices.

Switching between 16 sets of data

Up to 16 data sets consisting of 4 points of comparator setting values can be stored. Switching between the 16 data sets can be performed using key operations or by inputting external contact point signals.

Using external contact point input allows the comparator setting values to be switched immediately with respect to various measurements. (This is the same for positioning.)

Open collector output/relay output

Judgment results can be output in relay or open collector, allowing direct connection with PLC (Programmable Logic Controller) and other devices.

2. Name and Function of Each Part

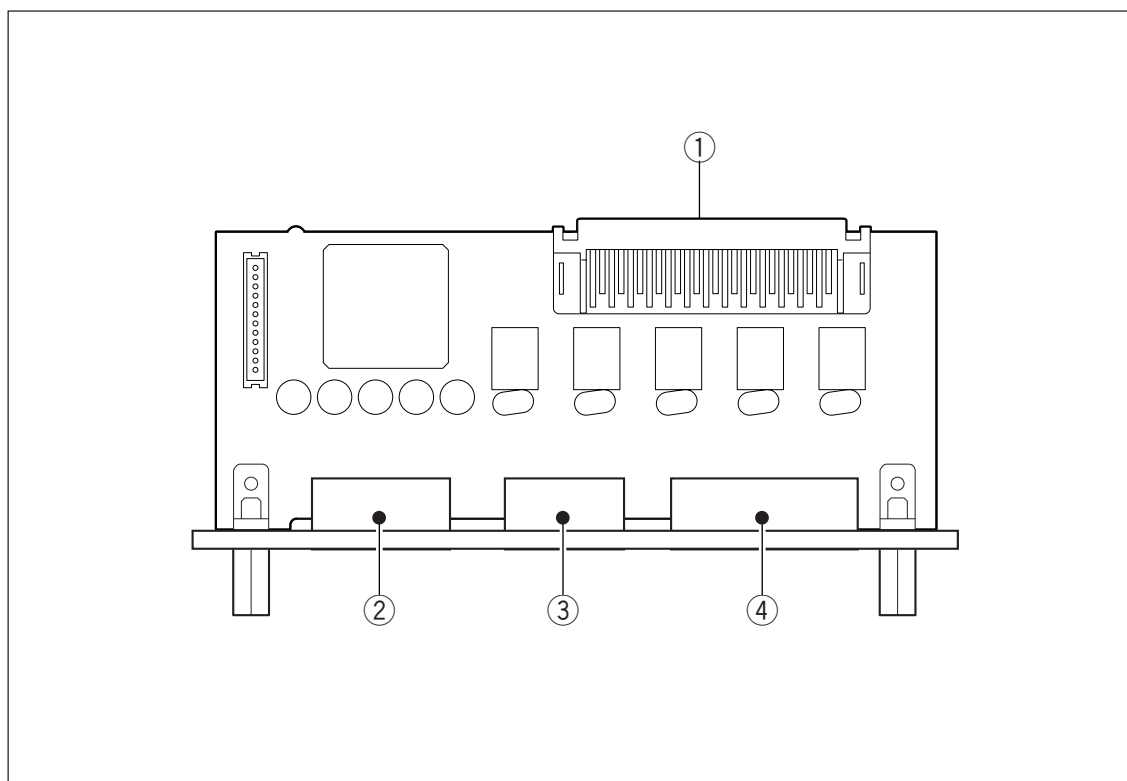

- ① **60-pin connector**
Used to insert the expansion unit into the LY unit body.
- ② **Input connector (set number/latch input)**
This is a counter unit connector that is used to switch set numbers and input latch signals.
- ③ **Output connector (open collector output)**
This is a counter unit connector that is used to output the comparator judgment.
- ④ **Output connector (relay output)**
This is a counter unit connector that is used to output the comparator judgment.

3. Installation and Connection

3-1. Installing the Expansion Unit

3-1-1. LZ71-KR

- 1 Remove the screening cover of the expansion unit slot and insert the expansion unit.
The expansion unit may be inserted in any of the two slots.
- 2 Secure the expansion unit firmly in place using the screws which held the screening cover in place.

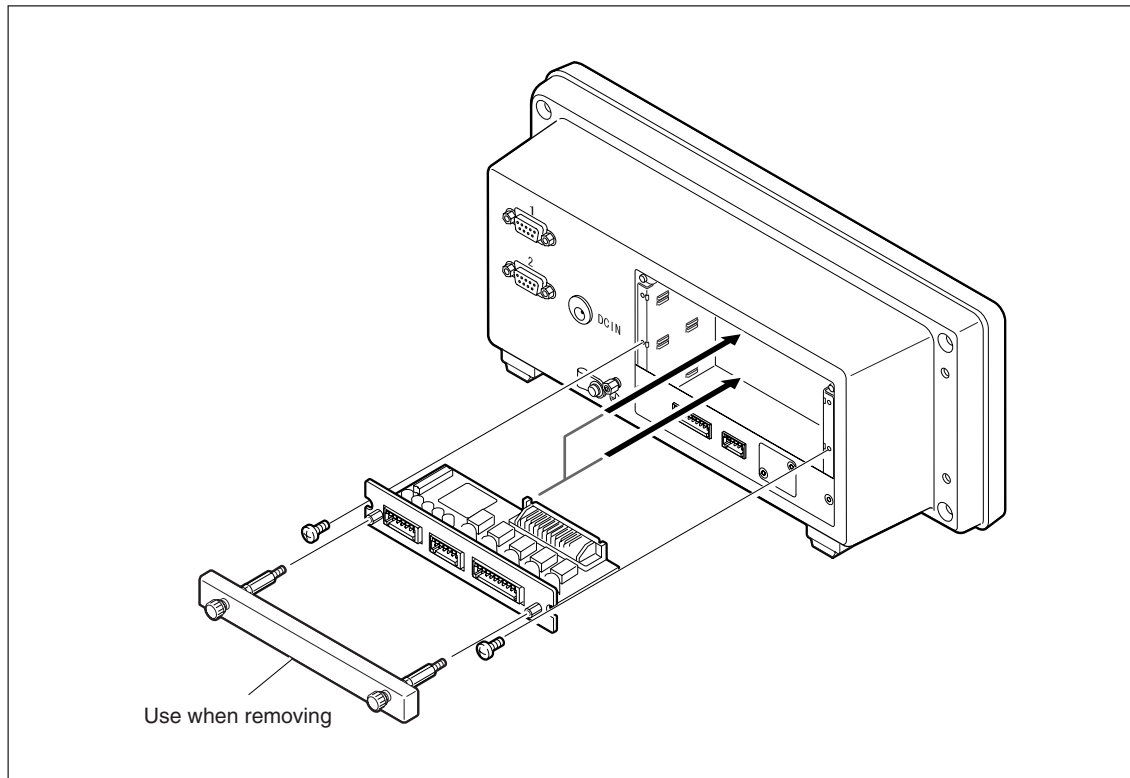

* Terminal block connector wiring

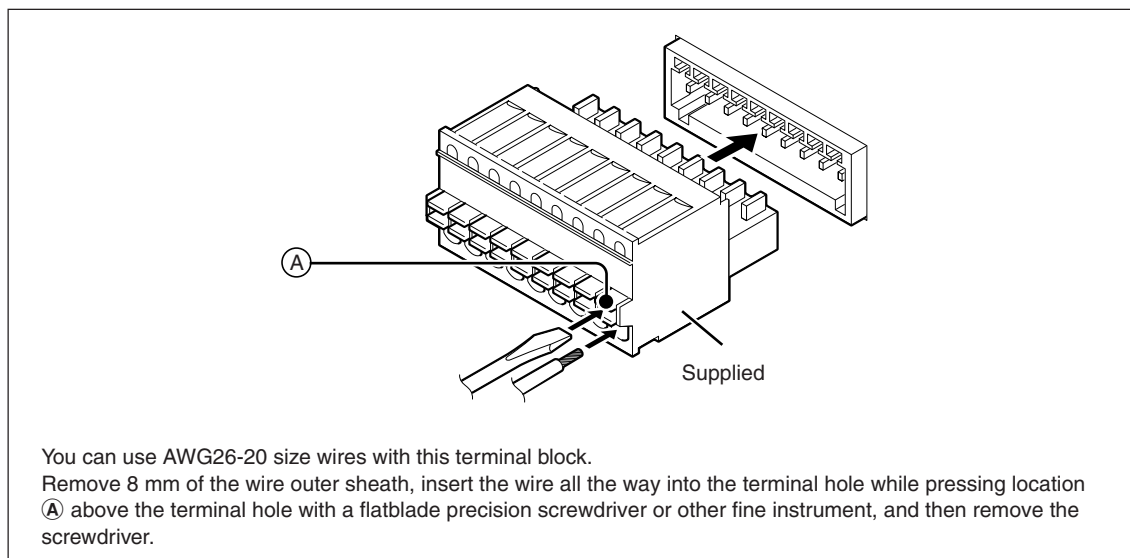

3-2. Connecting the Output Connector

3-2-1. Open collector output type

Output connector pin assignment

①	$\overline{OC0}$	OUT	: Outputs the output 0 signal.
②	$\overline{OC1}$	OUT	: Outputs the output 1 signal.
③	$\overline{OC2}$	OUT	: Outputs the output 2 signal.
④	$\overline{OC3}$	OUT	: Outputs the output 3 signal.
⑤	$\overline{OC4}$	OUT	: Outputs the output 4 signal.
⑥	COM	—	

Terminal arrangement

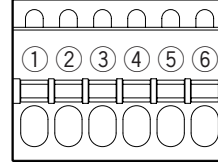

*1 See “7. Description of Operation” for the contents of output signals.

The wiring method is identical to that for the I/O terminal of the LY71 unit.

Interface cables

Use a shielded cable as shown in the figure for connection to the output cable, and connect the shield to that of the output cable.

Connect the COM terminal separately from the shield. (Please procure the shielded connection cable.)

Failure to use a shielded cable may result in misoperation due to external noise, etc.

Cable section

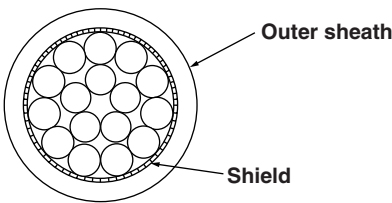

Connection circuits

• Output circuit

The judgment output signals are photocoupler compatible. (12 V to 24 V 15 mA max.)

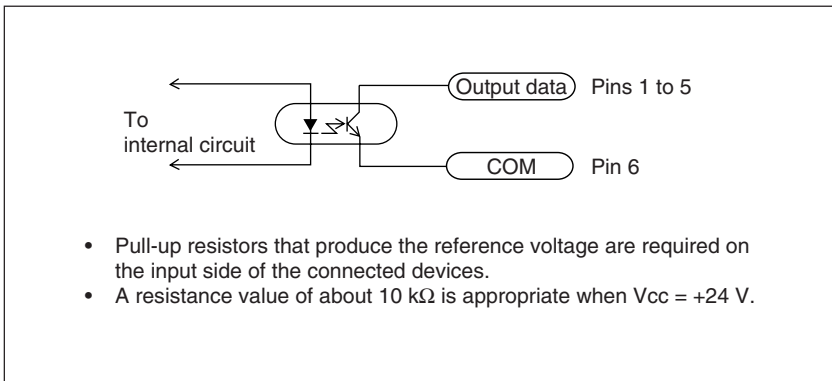

3-2-2. Relay output type

Relay output connector pin assignment

①	$\overline{RY0}$] Outputs the output 0 contact point output.
②	$RY0$	
③	$\overline{RY1}$] Outputs the output 1 contact point output.
④	$RY1$	
⑤	$\overline{RY2}$] Outputs the output 2 contact point output.
⑥	$RY2$	
⑦	$\overline{RY3}$] Outputs the output 3 contact point output.
⑧	$RY3$	
⑨	$\overline{RY4}$] Outputs the output 4 contact point output.
⑩	$RY4$	

Terminal arrangement

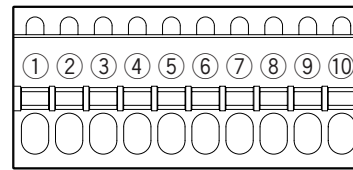

See “7. Description of Operation” for the contents of contact point outputs.
The wiring method is identical to that for the I/O terminal of the LY71 unit.

Interface cable

Use a shielded connection cable and connect the shield to a screw (GND) securing the expansion unit.
Use either of the two screws.

(Please procure the shielded cable.)

Failure to use a shielded cable may result in misoperation due to external noise, etc.

Cable section

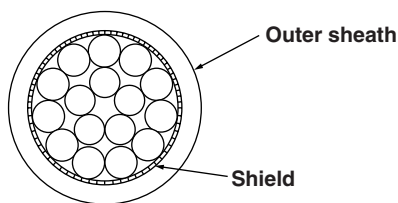

⚠ Caution

Use a power cable with a temperature rating of 60 °C (140 °F) or higher.

Output circuit

The relay output circuit is a product equivalent to “ATQ209” manufactured by Panasonic Electric Works Co., Ltd.

Output signal ratings

Rated operating voltage: 100 V AC, 24 V DC

Rated operating current: (resistance load) 0.3 A

Operation time: Approximately 2 ms

Recovery time: Approximately 1 ms

Electrical life: 100,000 times or more

The electrical life varies according to the operating voltage and current.

The electrical life lengthens as the voltage and current become smaller.

Specifications for the relay alone when used with the above ratings.

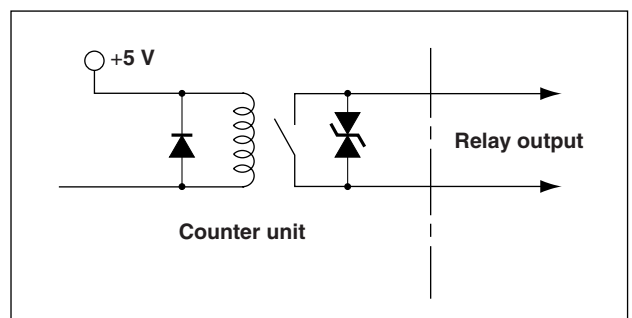

3-2-3. Comparator setting value switching input

Up to 16 data sets consisting of 4 points of comparator setting values can be stored. (For positioning, up to 16 data sets consisting of 1 point of positioning data can be stored.)

These 16 data sets can be switched externally using the input terminal.

Input signal pin assignment

①	+Vcc
②	CMP0
③	CMP1
④	CMP2
⑤	CMP3
⑥	LATCH
⑦	COM

Terminal arrangement

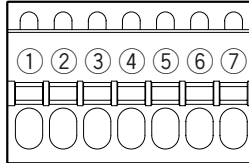

CMP0	H	L	H	L	H	L	H	L	H	L	H	L	H	L	H	L
CMP1	H	H	L	L	H	H	L	L	H	H	L	L	H	H	L	L
CMP2	H	H	H	H	L	L	L	L	H	H	H	H	L	L	L	L
CMP3	H	H	H	H	H	H	H	H	L	L	L	L	L	L	L	L
	1st set	2nd set	3rd set	4th set	5th set	6th set	7th set	8th set	9th set	10th set	11th set	12th set	13th set	14th set	15th set	16th set

- If CMP0 to 3 are not input, the 1st set is automatically selected.

Interface cables

Use a shielded interface cable as shown in the figure for connection to the terminal block connector, and connect the shield to the I/O connector shell.

Connect the COM terminal separately from the shield. Failure to use a shielded cable may result in misoperation due to external noise, etc. (Please procure the switch and shielded cable.)

Cable section

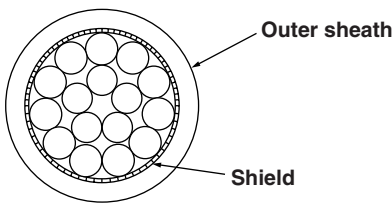

Connection circuits

• Input circuit

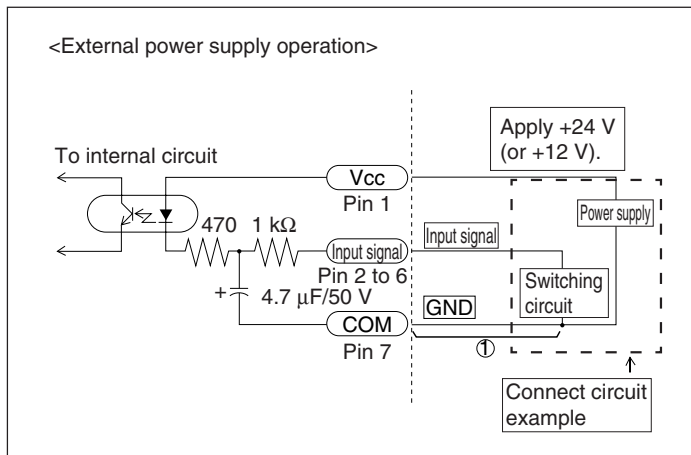

- When you use the external input, connect the external input terminal to the COM terminal for at least 10 ms.
When you input the external input signal again, provide an OFF time of at least 70 ms.

Input circuit delay time

When a signal is input to switch the comparator setting values, the input circuit produces a delay time until the signal is transmitted to the internal processing block. Care should be taken as this delay time varies widely according to the operating voltage of the input circuit.

(Example) During +24 V operation, there is a delay time of approximately 350 μ s until the signal is transmitted internally.

The processing time from when the signal is transmitted internally until the set number is actually switched varies according to the operating conditions. When not using any expansion unit other than the comparator unit, this processing time is a minimum of about 3 ms. When other expansion units are also installed, this time increases.

The delay time can be greatly shortened by not connecting portion ① of the circuit shown on the previous page. In this case, however, misoperation occurs easily due to noise, etc. Therefore, be sure to implement sufficient noise countermeasures for use with portion ① not connected.

Referense

When ① is not connected during +24 V operation:

Delay time = approximately 3 μ s

4. Settings

4-1. Advanced Settings

The comparator unit does not have any basic settings. Set the items needed in the LY71 advanced settings (see the LY71 Installation Manual) for use. The basic key operation procedures are identical to the LY71 unit.

Setting details

Display	Setting item	Setting value	Setting details
$\overline{C} \overline{n} P \rightarrow \overline{n} 0 d E$ <input type="checkbox"/> (A-axis display)	Output mode	<input type="checkbox"/> C L P	Display output Latch Positioning
$dR?$ <input checked="" type="radio"/> <input type="checkbox"/> (B-axis display)	Judgment target	<input checked="" type="radio"/> 1 2 R <input type="checkbox"/> C R I P	1st axis 2nd axis Addition axis Current value Maximum value Minimum value Peak-to-peak value
dSP <input type="checkbox"/>	Display switching	<input type="checkbox"/> L R	Manual Automatic

4-1-1. Output mode

- 1 Press the $\overline{\circ}$ key on counter display A.
- 2 Press the $\overline{\circ}$ key to select the output mode.
- 3 Press the $\overline{\circ}^{ENT}$ key.

4-1-2. Judgment target

This sets the data used for comparator operation.

- 1 Press the $\overline{\circ}$ key on comparator setting value display B.
- 2 Press the $\overline{\circ}$ key to select the data.
- 3 Press the $\overline{\circ}^{ENT}$ key.

4-1-3. Display switching

Only two comparator setting values can be displayed at the same time. If there are three or more setting values, switch the display to view the other setting values.

Display switching has the two modes below.

Auto mode : The setting values are automatically switched based on the status of the judgment result.

Manual mode: The $\text{○}^{\text{CR} \blacktriangle} / \text{○}^{\text{CR} \blacktriangledown}$ key is used to automatically switch the setting values.
(See “5-5. Display Switching”.)

- 1 Press the $\text{○}^{\blacktriangle}$ key on comparator setting value display C.
- 2 Press the $\text{○}^{\blacktriangledown}$ key to select the data.
- 3 Press the ○^{ENT} key.

CAUTION

If the display is switched to Auto mode, more than one comparator setting value cannot be added. To add more than one setting value, switch the display to Manual mode before performing operation.

OPERATION

Refer to this section during normal use.

5. Functions

This section gives information on the special functions of the LZ71-KR expansion units.

5-1. Comparator function

Four comparator setting values can be input (“6-2. Inputting and changing comparator setting values”) and compared with the current value. The judgment results are shown on the judgment display on the left side of the counter display.

Also, the judgment results can be output in either relay or open collector.

In addition to the current value, the maximum, minimum and peak-to-peak values can also be selected for comparison. (Based on the settings)

Up to 16 sets consisting of 4 points of comparator setting values can be stored, and sets are switched using key operations or contact point input signals.

The judgment conditions are as follows.

$$\left(\begin{array}{l} \text{Measurement value} < \text{Setting value 1: Output 0,} \\ \text{Setting value 1} \leq \text{Measurement value} < \text{Setting value 2: Output 1,} \\ \text{Setting value 2} \leq \text{Measurement value} < \text{Setting value 3: Output 2,} \\ \text{Setting value 3} \leq \text{Measurement value} < \text{Setting value 4: Output 3,} \\ \text{Setting value 4} \leq \text{Measurement value} \qquad \qquad \qquad : \text{Output 4} \end{array} \right)$$

5-2. Positioning function

This function sets the value for a certain point as the positioning data and outputs a signal for approximately 0.5 s when the set value and the current value match. (Output from output 0.)

The comparator function cannot be used together with this function. (Up to 16 points can be stored like the comparator function.)

Note that the data which can be used for positioning is the current values of the 1st axis, 2nd axis and addition axis. Peak values (maximum, minimum and peak-to-peak values) cannot be used.

5-3. Switching between 16 sets of data

16 sets of comparator function or positioning function data can easily be switched using key operations or external contact point input.

Switching using external contact point input is especially easy as only the input signal need be switched (see 3-2-3. (P. 3-4)).

Special care should be taken for the input circuit delay time (see “Input circuit delay time”. (P. 3-5)).

5-4. Latch

When latch input is entered, the judgment results can be latched.

5-5. Display switching

5-5-1. When display switching is set automatically

The comparator setting value display and judgment results appear as shown below.

Judgment display automatic switching

Example:

(When the current value is between setting values 1 and 2)

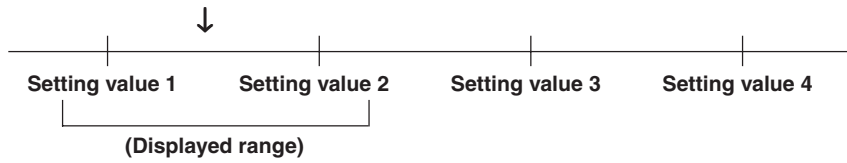

When using 4 level

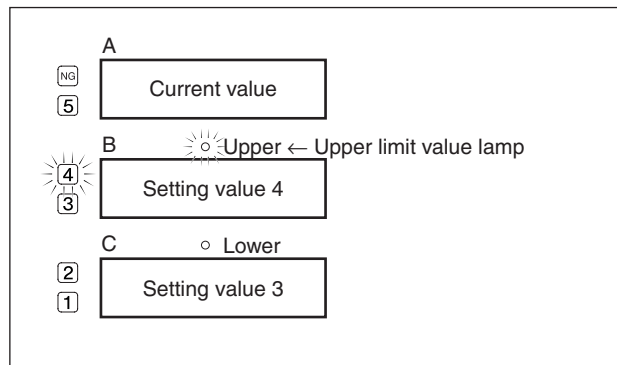
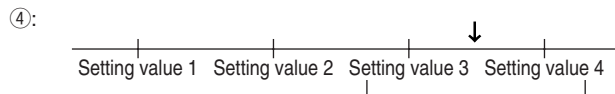
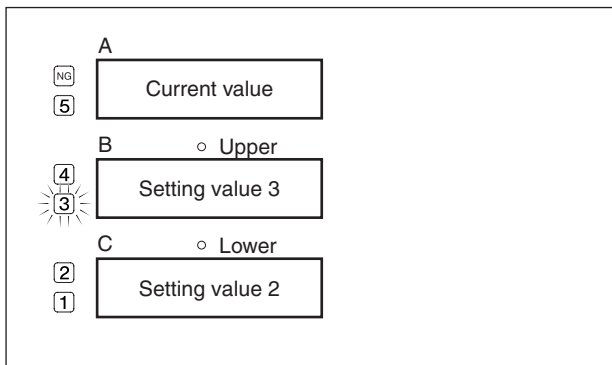
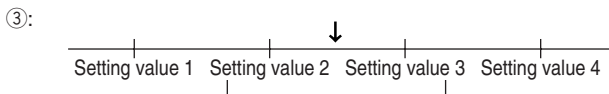
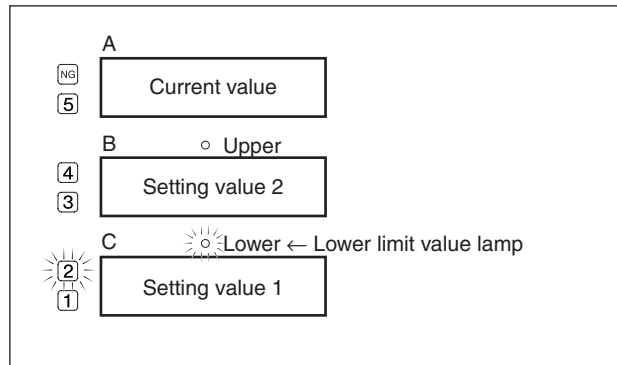
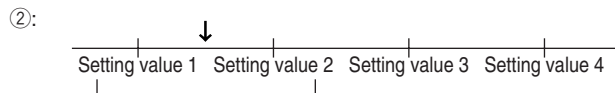
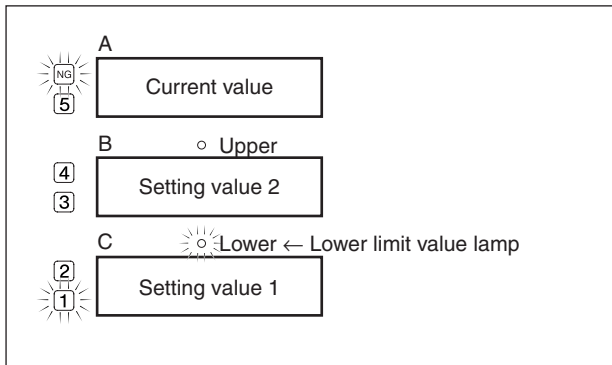
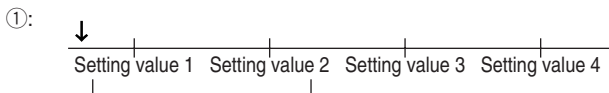

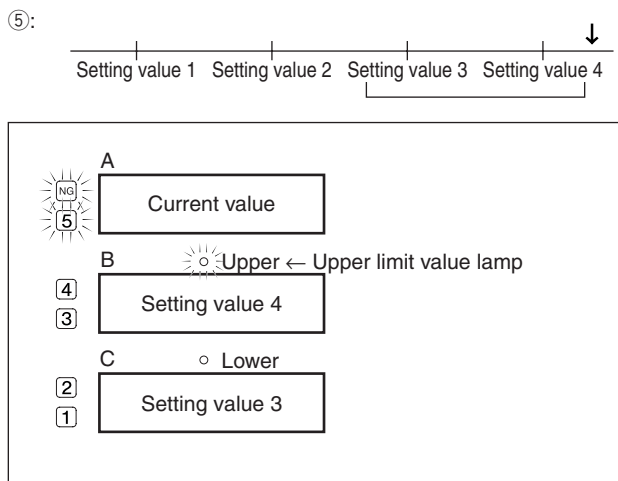

When using 3 level

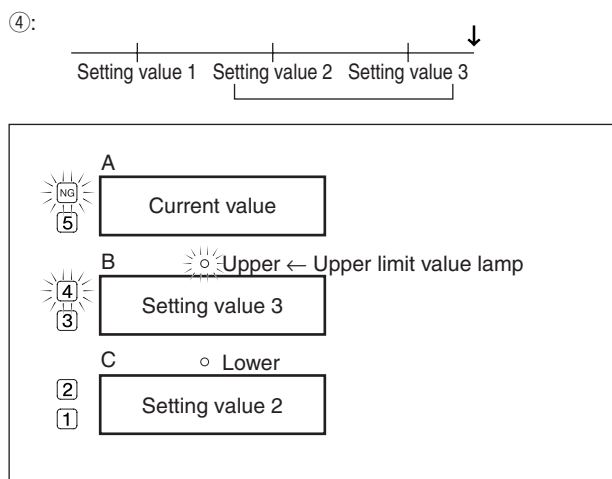
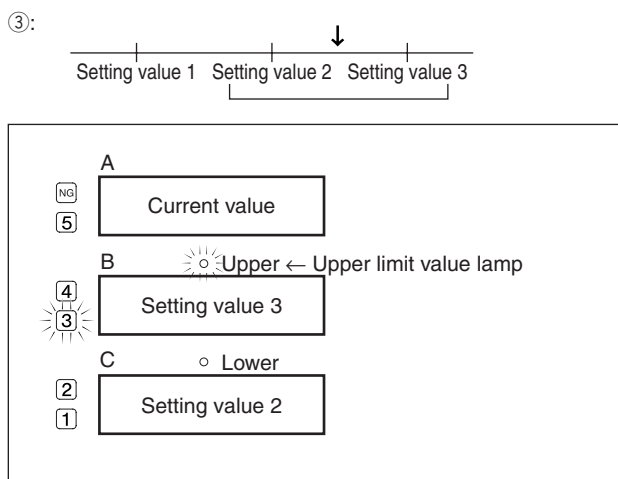
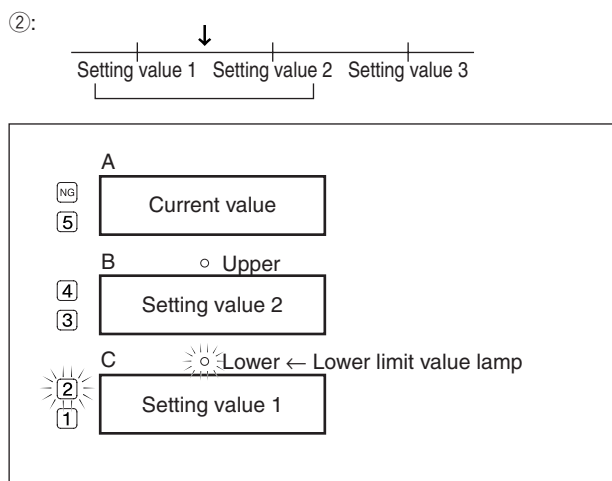
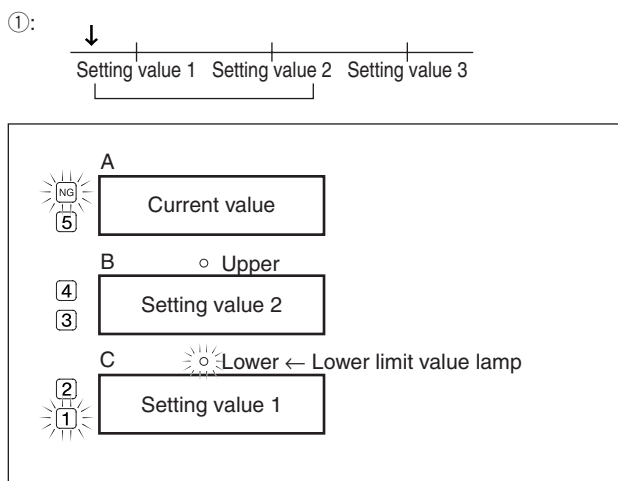

When using 2 level

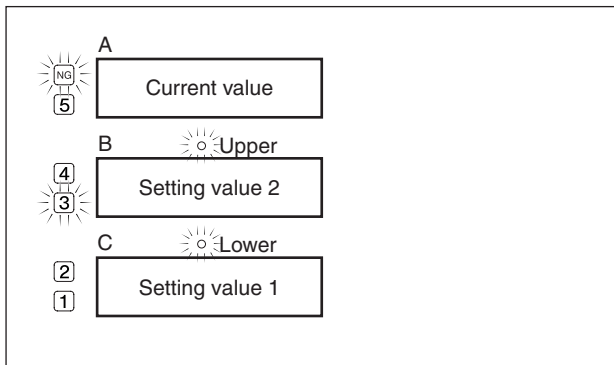
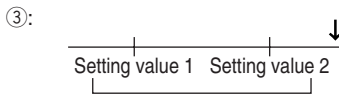
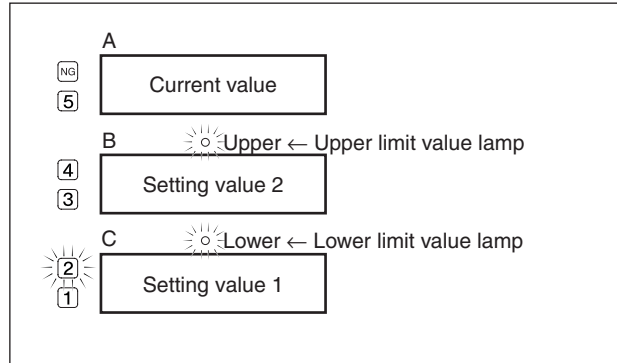
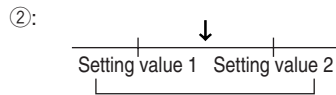
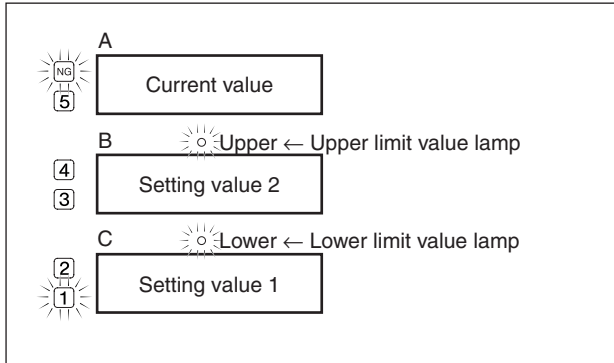
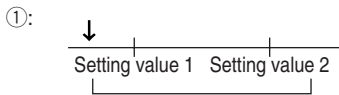

When using 1 level

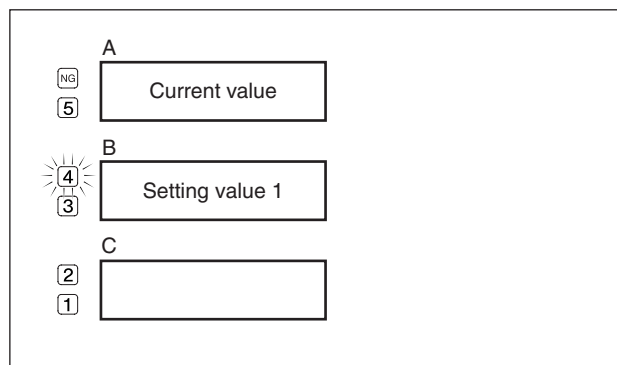
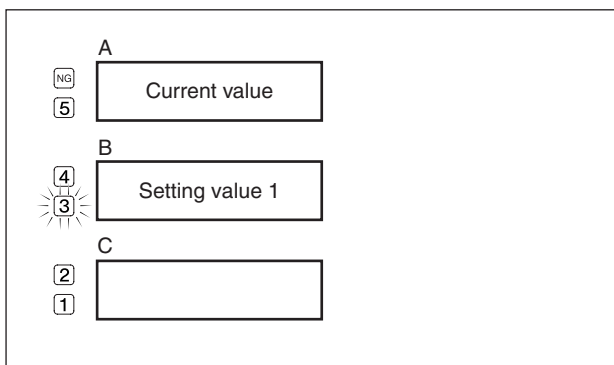
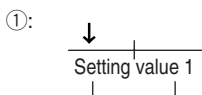

5-5-2. When display switching is set to manual

For details about the judgment results lamp, see “5-5-1. When display switching is set to automatically”.

The setting value is switched using the / key.

If a larger setting is available : Pressing the key displays this value.

If a smaller setting is available: Pressing the key displays this value.

6. Operation

6-1. Selecting the comparator set

This selects the 16 sets of comparator setting values.

- 1 Press the CP No. key.
..... Inputs the comparator set selection.
- 2 Use the numeric keys to enter the set number.
Reference
Canceling input : Press the \bigcirc^{CE} key.
- 3 Press the \bigcirc^{ENT} key.

The comparator set can also be selected from the input terminal. Whenever the input terminal state is changed, the set number also switches in response.

6-2. Inputting and changing comparator setting values

The comparator setting values are set in the order of setting value 1 < setting value 2 < setting value 3 < setting value 4.

- 1 Display the comparator setting that will be input or changed, and then press the $\bigcirc^{\blacktriangleleft}$ key.
..... The ABS lamp flashes to indicate that a numerical value can be entered.
The Upper lamp lights on if the maximum upper limit value is displayed. The Lower lamp lights on if the minimum lower limit value is displayed.
- 2 Use the numeric keys to enter the setting value.
Reference
Adding differences : Press the $\bigcirc^{\neq\Delta}$ key. The difference only can be input to the displayed setting value.
Canceling input : Press the \bigcirc^{CE} key.
Clearing data : Press the \bigcirc^{RESET} key during input of the numeric value. The data is cleared, and “- - - -” is displayed.
- 3 Press the \bigcirc^{ENT} key.
..... The setting value is stored.

Note

- An entered value that is smaller than the previous setting value cannot be set. (Example: If you try to enter a setting value for setting value 2 that is smaller than setting value 1, an error sound is made, and the setting value is not stored.)
- When changing the setting value, if the entered value is larger than setting values coming after, the setting values coming after are all erased. (Example, if you change setting value 2 to a value larger than setting value 3, setting values 3 and 4 will be erased.)
- If the display is switched to Auto mode, more than one comparator setting value cannot be added. To add more than one setting value, switch the display to Manual mode before performing operation.

Reference

- To change setting values that are not displayed when automatic display switching (see “4-1. Advanced Settings”) is set, you must change the display switching setting to Manual, display the setting value, and then make the change.
- When no setting values are set, the “- - - -” display is shown.

7. Description of Operation

7-1. Comparator Function

Output is as follows according to the size of the compared value (measurement value).

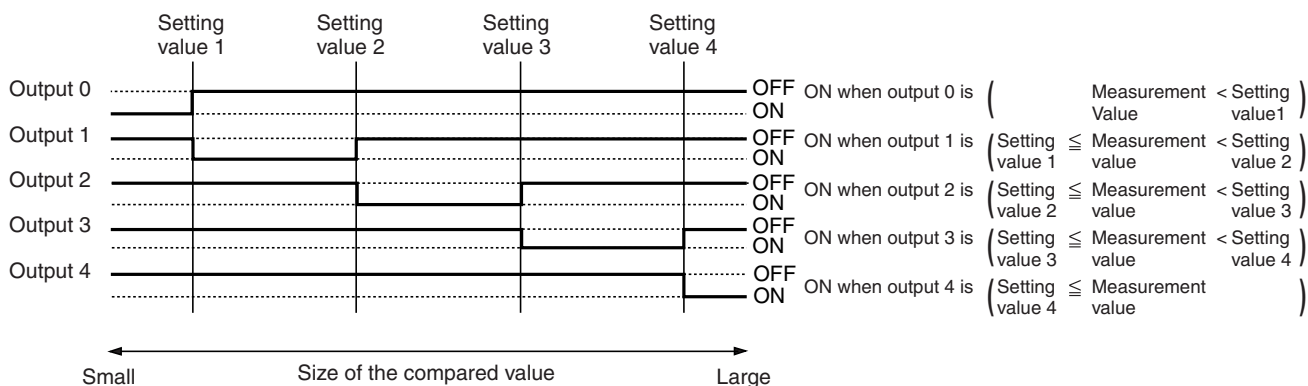

Note

The timing at which the output is updated varies according to the types and number of connected expansion units, as well as the number of connected measuring unit axes (1 or 2). When using the LY71 with one other expansion unit in addition to the comparator and only one axis, the output is updated once every approximately 13 to 14 ms.

7-2. Positioning Function

A signal is output for approximately 0.5 s after the measuring unit goes past the setting value. (When moving in either the plus or minus direction)

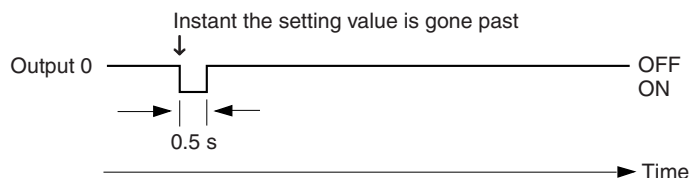

Note

The timing at which the output is updated is the same as that for the comparator function.

8. Troubleshooting

See the LY71 instruction manual for trouble related to the LY71 unit.

This section describes the troubleshooting procedures related to comparator output.

**There is no
comparator output
(positioning output).**





- Are the comparator setting values (positioning setting values) set correctly?
- Is the comparator set selection signal (positioning set selection signal) being input correctly? Were the set selection key operations performed correctly? Are any unnecessary sets selected?
- Is the cable connected correctly? or is the cable broken?

**The comparator
output (positioning
output) is incorrect.**



- Are the comparator setting values (positioning setting values) set correctly?
- Is the comparator set selection signal (positioning set selection signal) being input correctly? Were the set selection key operations performed correctly? Are any unnecessary sets selected?
- Is the cable connected correctly? or is the cable broken?
- Is the output mode during latch set correctly? (Check the setting.) → (See “4-1-1. Output mode”.)

9. Specifications

Item	Contents
Comparator function	Sets 1 to 4 comparator values for judging the data size.
Comparable data	Current, maximum, minimum and peak-to-peak values. (Based on the settings) (1st axis, 2nd axis and addition axis)
Upper limit and lower limit combinations	Selectable from 16 data sets consisting of 1 to 4 comparator setting values. Data sets can be selected using [1]  key operations or [2] external contact point inputs (4) [1] Selecting the 16 sets using  key operations [2] Using the external contact point inputs (4): (HHHH) = 1st set (default) (HHHL) = 2nd set (HHLH) = 3rd set (HLLH) = 4th set : (LLLH) = 15th set (LLLL) = 16th set
Judgment outputs	5-point output signal Photocoupler (voltage resistance: 24 V), I _c = 15 mA 5-point output signal Relay: Panasonic Electric Works Co., Ltd. ATQ209 24 V DC, 120 V AC, 0.3 A
External input	Photo coupler: supports 12 to 24 V
Positioning function (1 point) modes	Sets the positioning data and turns the output signal on for 0.5 s when the set value and the current value match.
Applicable data	Current value only (1st axis or addition axis)
Types of positioning values	16 sets of data consisting of one positioning value each can be selected. The selection method is the same as for the comparator function.
Operating temperature/humidity range	0 to 40 °C (No condensation)
Storage temperature/humidity range	-20 to 60 °C (20 to 90 % RH, no condensation)

10. Dimensions

Specifications and appearances of the products are subject to change for improvement without prior notice.

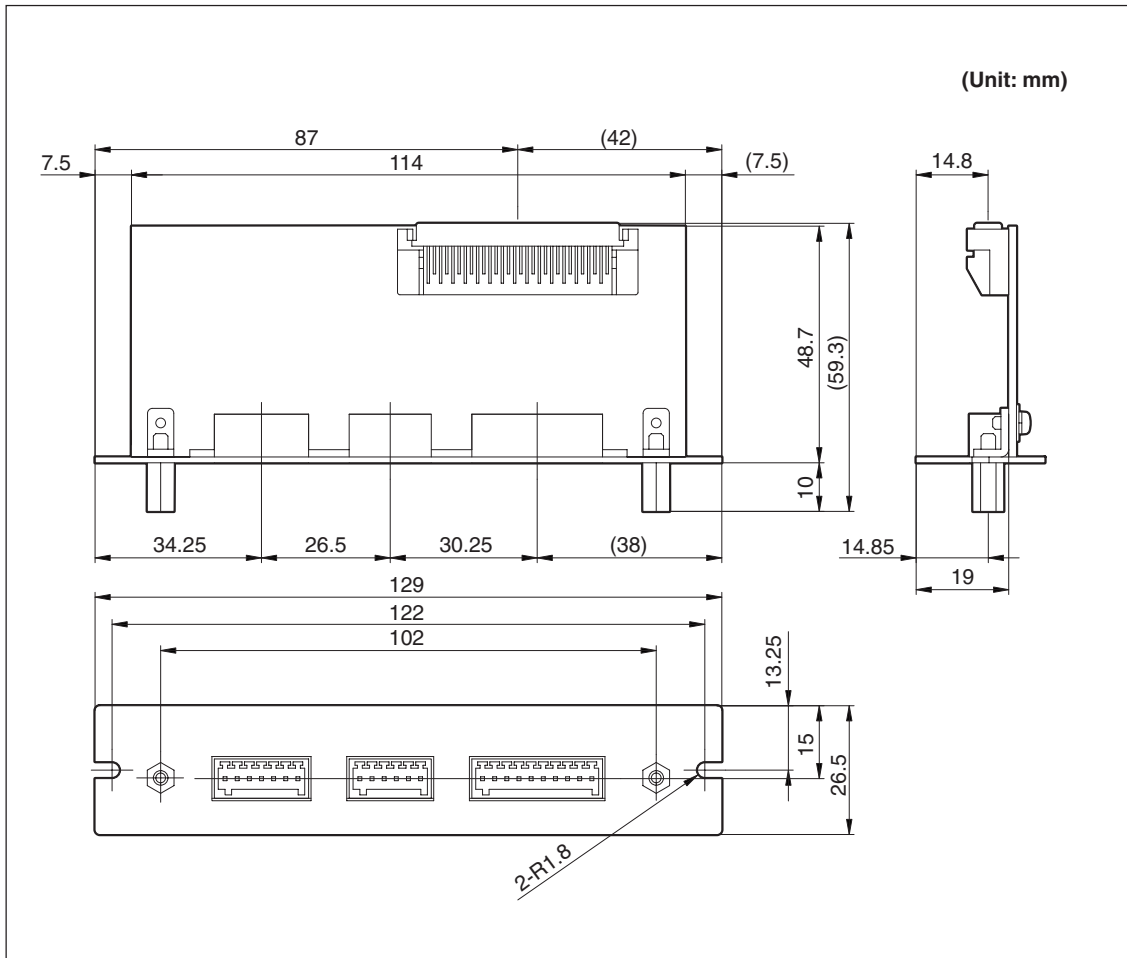

このマニュアルに記載されている事柄の著作権は当社にあり、説明内容は機器購入者の使用を目的としています。したがって、当社の許可なしに無断で複製したり、説明内容(操作、保守など)と異なる目的で本マニュアルを使用することを禁止します。

本手册所记载的内容的版权归属Magnescale Co., Ltd., 仅供购买本手册中所记载设备的购买者使用。

除操作或维护本手册中所记载设备的用途以外, 未经 Magnescale Co., Ltd. 的明确书面许可, 严禁复制或使
用本手册的任何内容。

The material contained in this manual consists of information that is the property of Magnescale Co., Ltd. and is intended solely for use by the purchasers of the equipment described in this manual. Magnescale Co., Ltd. expressly prohibits the duplication of any portion of this manual or the use thereof for any purpose other than the operation or maintenance of the equipment described in this manual without the express written permission of Magnescale Co., Ltd.

Le matériel contenu dans ce manuel consiste en informations qui sont la propriété de Magnescale Co., Ltd. et sont destinées exclusivement à l'usage des acquéreurs de l'équipement décrit dans ce manuel.

Magnescale Co., Ltd. interdit formellement la copie de quelque partie que ce soit de ce manuel ou son emploi pour tout autre but que des opérations ou entretiens de l'équipement à moins d'une permission écrite de Magnescale Co., Ltd.

Die in dieser Anleitung enthaltenen Informationen sind Eigentum von Magnescale Co., Ltd. und sind ausschließlich für den Gebrauch durch den Käufer der in dieser Anleitung beschriebenen Ausrüstung bestimmt.

Magnescale Co., Ltd. untersagt ausdrücklich die Vervielfältigung jeglicher Teile dieser Anleitung oder den Gebrauch derselben für irgendeinen anderen Zweck als die Bedienung oder Wartung der in dieser Anleitung beschriebenen Ausrüstung ohne ausdrückliche schriftliche Erlaubnis von Magnescale Co., Ltd.

日本からの輸出時における注意

本製品(および技術)は輸出令別表第1の16の項(外為令別表16の項)に該当します。キャッチオール規制による経済産業省の許可要否につきましては、輸出者様にてご確認ください。

For foreign customers

Note: This product (or technology) may be restricted by the government in your country. Please make sure that end-use, end user and country of destination of this product do not violate your local government regulation.

Magnescale Co., Ltd.

45 Suzukawa, Isehara-shi, Kanagawa 259-1146, Japan