

SL

SL331 PL60

Non-contact, detection and a high response speed

Magnescale® Digiruler®

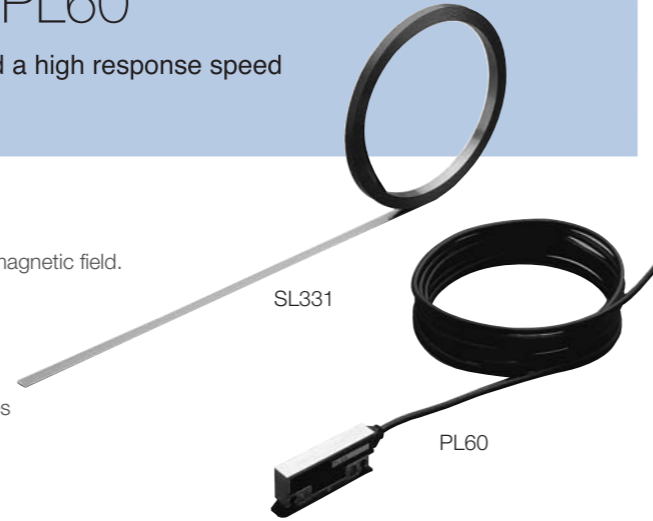

- Magnetic principle
- Excellent resistance to workshop conditions (IP65). Resistant to oil, dirt, vibrations and shocks. Read head resistant to external magnetic field.
- Accuracy: $(15 + 5L / 1000) \mu\text{m}$ (L=measuring length in mm)
- Resolution: SL331 with PL60 → $5 \mu\text{m}, 10 \mu\text{m}$
- High response speed: 250 m/min with a resolution of $5 \mu\text{m}$
- Measuring lengths of up to 8 m / 314.9"
- Easy installation
- Automatic position control for layout machines and other dedicated machines

Example for connection

Scale	Head	Cable	Interpolator
SL331	PL60	CE08 CK-T12/13/14/15/16	MJ100/110

Dimensions

SL331

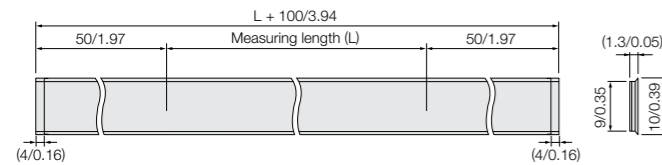

PL60

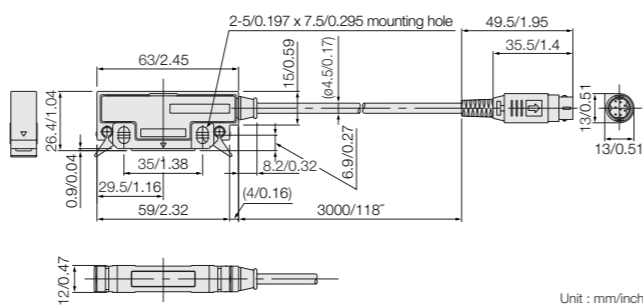

Unit : mm/inch

SL331 Specifications

Model	SL331-20 to SL331-800
Effective length L mm (inch)	200/300/400/500/600/700/800/1000/1200/1500/1600/1700/1800/2000/2500/3000/4000/5000/6000/7000/8000 (7.8/11.8/15.7/19.6/23.6/27.5/31.4/39.3/47.2/59.0/62.9/66.9/70.8/78.7/98.4/118.1/157.4/196.8/236.2/275.5/314.9)
Overall length	L + 100 mm / 3.9"
Accuracy (20 °C / 68 °F)	$(15 + 5L / 1000) \mu\text{m}$
Resolution	$5 \mu\text{m}$
Max. response speed	Varies with the resolution
Expansion coefficient	$(10.4 \pm 1) \times 10^{-6} / ^\circ\text{C}$
Operating temperature	-5 °C to 45 °C / 23 °F to 113 °F
Storage temperature	-10 °C to 50 °C / 14 °F to 122 °F
Compatible read head	PL60

PL60 Specifications

Model	PL60-3
Head clearance	Max. 0.8 mm / 0.031" (no contact)
Protective design grade	Equivalent to IP65
Operating temperature	-5 °C to 45 °C / 23 °F to 113 °F
Storage temperature	-10 °C to 50 °C / 14 °F to 122 °F
Read head cable length	3 m / 9.8'
Compatible scale	SL331
Compatible interpolator	MJ100/ 110
Extension cable (option)	CE08-01...1m, CE08-03...3m, CE08-05...5m, CE08-10...10m, CE08-15...15m

*Cable length of more than 15m, Please consult our sales.

Response speed of PL60

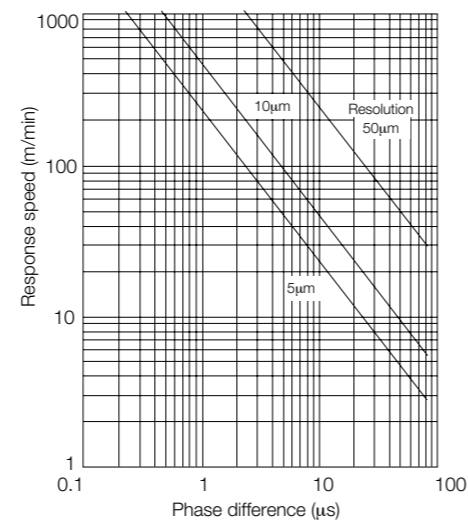

SL

SL110/SL130

Non-contact detection and a long measuring range

Magnescale® Digiruler®

- Magnetic principle
- Excellent resistance to workshop conditions (PL20C equivalent to IP65). Resistant to oil, dirt, vibration, and shock.
- Resolution: $10 \mu\text{m}$
- Max. response speed: 300 m/min (varies with the read head and settings).
- Available in lengths up to 30 m (SL130)
- High cost efficiency. Easy installation on all types of machines from wood working to metal cutting.

Example for connection

Scale	Headcable	Cable	Interpolator
SL110/130	PL25	CE08 CK-T12/13/14/15/16	MJ100/110
	PL20C	LH71A/72 LY71/72	

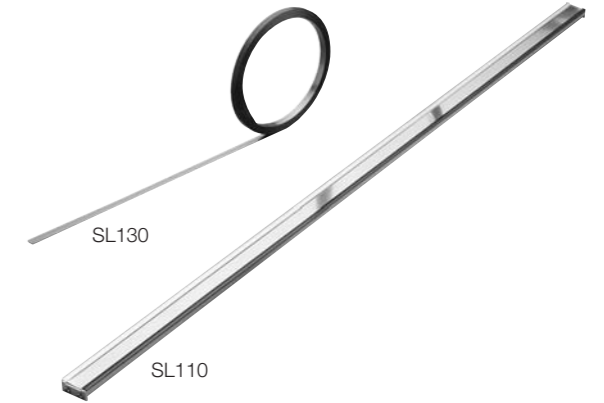

Dimensions

SL110

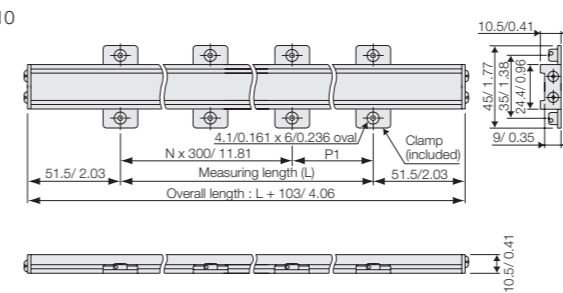

SL130

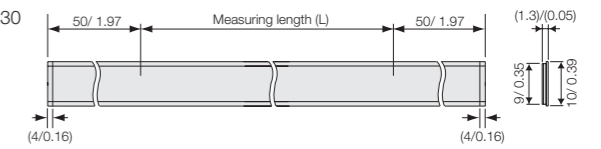

Model name	Effective length	N	P1	Number of Clamps
SL110-20	200	0	200	4
SL110-30	300	1	0	4
SL110-40	400	1	100	6
SL110-50	500	1	200	6
SL110-60	600	2	0	6
SL110-70	700	2	100	8
SL110-80	800	2	200	8
SL110-100	1000	3	100	10
SL110-120	1200	4	0	10
SL110-150	1500	5	0	12
SL110-160	1600	5	100	14
SL110-170	1700	5	200	14
SL110-180	1800	6	0	14
SL110-200	2000	6	200	16

Model name	Effective length	Movable length	Overall length
SL130-20	200	230	300
SL130-30	300	330	400
SL130-40	400	430	500
SL130-50	500	530	600
SL130-60	600	630	700
SL130-70	700	730	800
SL130-80	800	830	900
SL130-100	1000	1030	1100
SL130-120	1200	1230	1300
SL130-150	1500	1530	1600
SL130-160	1600	1630	1700
SL130-170	1700	1730	1800
SL130-180	1800	1830	1900
SL130-200	2000	2030	2100
SL130-250	2500	2530	2600
SL130-300	3000	3030	3100
SL130-400	4000	4030	4100
SL130-500	5000	5030	5100
SL130-600	6000	6030	6100
SL130-700	7000	7030	7100
SL130-800	8000	8030	8100

Unit : mm/inch

SL110/130 Specifications

Model	SL110	SL130	
	-20 to -200	-20 to -700	-800 to -3000
Effective length L mm (inch)	200/300/400/500/600/700/800/1000/1200/1500/1600/1700/1800/2000	200/300/400/500/600/700/800/1000/1200/1500/1600/1700/1800/2000/2500/3000/4000/5000/6000/7000	8000/9000/10000/20000/30000 (314.9/354.3/393.7/787.4/1181.1)
Overall length	L + 103 mm / 4.1"	L + 100 mm / 3.9"	
Accuracy (20 °C / 68 °F)	$(50 + 10L / 1000) \mu\text{m}$		$(50 + 10L / 1000 + 20N) \mu\text{m}$ L : Measuring length(mm) N=1 when L=8000/9000/10000, N=2 when L=20000, N=3 when L=30000
Resolution	10 μm		
Max. response speed	300 m / min		
Expansion coefficient	$(10.4 \pm 1) \times 10^{-6} / ^\circ\text{C}$		
Operating temperature	-5 °C to 45 °C / 23 °F to 113 °F		
Storage temperature	-10 °C to 50 °C / 14 °F to 122 °F		
Compatible read head	PL20B/ 25		
Compatible read head and Interpolator	PL81/ 82 Series		

*Accuracy shows the value when used with PL20B/25 read head and PL81/82.